

Quasar™ Gen III User Guide



CP-6302-30-R



CP-6302-31-P



CP-6302-31-I

© 2022 Teledyne FLIR LLC All rights reserved worldwide. No parts of this manual, in whole or in part, may be copied, photocopied, translated, or transmitted to any electronic medium or machine readable form without the prior written permission of Teledyne FLIR LLC.

Names and marks appearing on the products herein are either registered trademarks or trademarks of Teledyne FLIR LLC and/or its subsidiaries. All other trademarks, trade names, or company names referenced herein are used for identification only and are the property of their respective owners. This product is protected by patents, design patents, patents pending, or design patents pending. Photographs and images appearing in this manual may have been modified for illustrative purposes using commercial image editing software and may not always reflect an actual product configuration. The contents of this document are subject to change without notice.

For additional information visit www.flir.com or write to Teledyne FLIR LLC

Teledyne FLIR LLC

6769 Hollister Avenue

Goleta, CA 93117

Support: <https://support.www.flir.com/>

Proper Disposal of Electrical and Electronic Equipment (EEE)

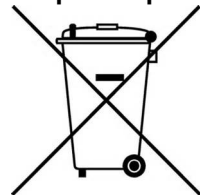

The European Union (EU) has enacted Waste Electrical and Electronic Equipment Directive 2012/19/EU (WEEE), which aims to prevent EEE waste from arising; to encourage reuse, recycling, and recovery of EEE waste; and to promote environmental responsibility.

In accordance with these regulations, all EEE products labeled with the “crossed out wheeled bin” either on the product itself or in the product literature must not be disposed of in regular rubbish bins, mixed with regular household or other commercial waste, or by other regular municipal waste collection means. Instead, and in order to prevent possible harm to the environment or human health, all EEE products (including any cables that came with the product) should be responsibly discarded or recycled.

To identify a responsible disposal method nearby, please contact the local waste collection or recycling service, the original place of purchase or product supplier, or the responsible government authority in the area. Business users should contact their supplier or refer to their purchase contract.

Document History

Version	Date	Comment
Ver. 1 UL	March 27, 2018	Third Release
Ver. 6	December 13, 2018	QR-code access to product documentation and software downloads SD Card min/max
Ver. 7	February 5, 2020	Update Package contents, details on Waterproofing cables, UPoE via network switch
Ver. 8	January 31, 2021	Moved installation content to Installation Manual
Ver. 9	December 24, 2021	Teledyne FLIR company name change; camera browser-based user interface support for Google Chrome®, Mozilla Firefox®, and

Product Registration and Warranty Information

Register your Product with Teledyne FLIR at <https://customer.flir.com>.

For warranty information, see <https://www.flir.com/support-center/warranty/security/flir-security-product-warranties/>.

Table of Contents

1. Document Scope and Purpose	1
2. Accessing Product Information from the Teledyne FLIR Website	5
3. Overview	7
3.1 Features	8
3.2 Package Contents	9
3.3 Camera Dimensions	10
3.4 System Requirements	11
4. Installation	12
5. Configuration and Operation	13
5.1 Adjusting and Framing-Up the Camera View	13
5.2 Browser-Based Viewer Introduction	15
5.3 Live Screen	16
5.4 System Tab	19
5.4.1 System	20
5.4.2 Security	21
5.4.2.1 User	21
5.4.2.2 HTTPS	23
5.4.2.3 IP Filter	25
5.4.2.4 IEEE 802.1X	26
5.4.3 Network	27
5.4.3.1 Basic	28
5.4.3.2 QoS	30
5.4.3.3 SNMP	30
5.4.3.4 UPnP	32
5.4.3.5 DDNS	33
5.4.3.6 Mail	34
5.4.3.7 FTP	34
5.4.3.8 HTTP	35
5.4.4 Events Setup	36
5.4.4.1 IO	36
5.4.4.2 Network Failure Detection	38
5.4.4.3 Tampering	39
5.4.4.4 Periodic Event	42
5.4.4.5 Manual Trigger	43
5.4.4.6 Audio Detection	44
5.4.4.7 Triggered Actions	46

Table of Contents

5.4.5	Edge Recording	49
5.4.5.1	SD Card	49
5.4.5.2	Network Share	51
5.4.5.3	Recording	52
5.4.6	Motion Detection	53
5.4.7	Schedule	56
5.4.8	File Location	57
5.4.9	Maintenance	57
5.4.9.1	Log File	57
5.4.9.2	User Information	58
5.4.9.3	Factory Default	59
5.4.9.4	Software Version	60
5.4.9.5	Software Upgrade	61
5.4.9.6	Parameters	62
5.5	Import/Export	63
5.6	Streaming Tab	63
5.6.1	Video Configuration	64
5.6.1.1	Video Resolutions	64
5.6.1.1.1	Single-Stream H.265	65
5.6.1.1.2	Single-Stream H.264	67
5.6.1.1.3	Single-Stream MJPEG	67
5.6.1.1.4	Dual-Stream	68
5.6.1.1.5	Triple-Stream	71
5.6.1.1.6	Quad-Stream	73
5.6.2	Video Rotation	77
5.6.3	Video Text Overlay	78
5.6.4	Video OCX Protocol	79
5.6.5	Audio	80
5.7	Camera Tab	81
5.7.1	Exposure Screen	82
5.7.1.1	Auto Iris Mode	82
5.7.1.2	P-Iris Priority Mode	83
5.7.1.3	Iris Priority Mode	83
5.7.1.4	Auto Shutter Mode	84
5.7.1.5	Shutter Priority Mode	84
5.7.1.6	Manual Mode	85
5.7.2	Picture Adjustment	86

Table of Contents

5.7.3	Advanced Picture Settings	86
5.7.3.1	White Balance	87
5.7.3.2	Backlight Compensation	87
5.7.3.3	WDR Function	88
5.7.3.4	Noise Reduction Settings	88
5.7.4	IR Function	89
5.7.5	Misc. Screen	90
5.8	PTZ Tab	92
5.8.1	Preset	93
5.8.2	Pattern	93
5.8.3	Auto Pan	94
5.8.4	Sequence	95
5.8.5	Home	96
5.8.6	Tilt Range	96
5.8.7	Privacy Mask	97
5.8.8	PTZ Setting	97
5.8.9	RS485	98
5.9	Log Out	99
6.	Appendices	100
6.1	Technical Specifications	101
6.1.1	Accessing Product Information from the Teledyne FLIR Website	101
6.2	Internet Security Settings	103
6.3	Install UPnP Components	105
6.4	Installing and Deleting the Web Player	107
6.5	Deleting Temporary Internet Files	109

1 Document Scope and Purpose

This document describes how to operate and configure a CP-6302 Range camera after installing it. For information about mounting and initially configuring the camera, see the *Quasar Gen III CP-6302 Range Installation Manual*.



Note:

This document is intended for use by technical users who have a basic understanding of CCTV camera/video equipment and LAN/WAN network connections.

Remarque:

Ce document est destiné aux utilisateurs techniciens qui possèdent des connaissances de base des équipements vidéo/caméras de télésurveillance et des connexions aux réseaux LAN/WAN.



Warning:

Installation must follow safety, standards, and electrical codes as well as the laws that apply where the units are being installed.

Avertissement:

L'installation doit respecter les consignes de sécurité, les normes et les codes électriques, ainsi que la législation en vigueur sur le lieu d'implantation des unités.

Disclaimer

Users of Teledyne FLIR products accept full responsibility for ensuring the suitability and considering the role of the product detection capabilities and their limitation as they apply to their unique site requirements.

Teledyne FLIR LLC and its agents make no guarantees or warranties to the suitability for the users' intended use. Teledyne FLIR LLC accepts no responsibility for improper use or incomplete security and safety measures.

Failure in part or in whole of the installer, owner, or user in any way to follow the prescribed procedures or to heed WARNINGS and CAUTIONS shall absolve Teledyne FLIR and its agents from any resulting liability.

Specifications and information in this guide are subject to change without notice.

Avis de non-responsabilité

Il incombe aux utilisateurs des produits Teledyne FLIR de vérifier que ces produits sont adaptés et d'étudier le rôle des capacités et limites de détection du produit appliqués aux exigences uniques de leur site.

Teledyne FLIR LLC et ses agents ne garantissent d'aucune façon que les produits sont adaptés à l'usage auquel l'utilisateur les destine. Teledyne FLIR LLC ne pourra être tenu pour responsable en cas de mauvaise utilisation ou de mise en place de mesures de sécurité insuffisantes.

Le non respect de tout ou partie des procédures recommandées ou des messages d'AVERTISSEMENT ou d'ATTENTION de la part de l'installateur, du propriétaire ou de l'utilisateur dégagera Teledyne FLIR LLC et ses agents de toute responsabilité en résultant.

Les spécifications et informations contenues dans ce guide sont sujettes à modification sans préavis.



A **Warning** is a precautionary message that indicates a procedure or condition where there are potential hazards of personal injury or death.

***Avertissement** est un message préventif indiquant qu'une procédure ou condition présente un risque potentiel de blessure ou de mort.*



A **Caution** is a precautionary message that indicates a procedure or condition where there are potential hazards of permanent damage to the equipment and or loss of data.

***Attention** est un message préventif indiquant qu'une procédure ou condition présente un risque potentiel de dommages permanents pour l'équipement et/ou de perte de données.*



A **Note** is useful information to prevent problems, help with successful installation, or to provide additional understanding of the products and installation.

*Une **Remarque** est une information utile permettant d'éviter certains problèmes, d'effectuer une installation correcte ou de mieux comprendre les produits et l'installation.*



A **Tip** is information and best practices that are useful or provide some benefit for installation and use of Teledyne FLIR products.

*Un **Conseil** correspond à une information et aux bonnes pratiques utiles ou apportant un avantage supplémentaire pour l'installation et l'utilisation des produits Teledyne FLIR.*

General Cautions and Warnings

This section contains information that indicates a procedure or condition where there are potential hazards.

SAVE ALL SAFETY AND OPERATING INSTRUCTIONS FOR FUTURE USE.

Although the unit is designed and manufactured in compliance with all applicable safety standards, certain hazards are present during the installation of this equipment.

To help ensure safety and to help reduce risk of injury or damage, observe the following:

Précautions et avertissements d'ordre général

Cette section contient des informations indiquant qu'une procédure ou condition présente des risques potentiels.

CONSERVEZ TOUTES LES INSTRUCTIONS DE SÉCURITÉ ET D'UTILISATION POUR POUVOIR VOUS Y RÉFÉRER ULTÉRIEUREMENT.

Bien que l'unité soit conçue et fabriquée conformément à toutes les normes de sécurité en vigueur, l'installation de cet équipement présente certains risques.

Afin de garantir la sécurité et de réduire les risques de blessure ou de dommages, veuillez respecter les consignes suivantes:



Caution:

- The unit's cover is an essential part of the product. Do not open or remove it.
- Never operate the unit without the cover in place. Operating the unit without the cover poses a risk of fire and shock hazards.
- Do not disassemble the unit or remove screws. There are no user serviceable parts inside the unit.
- Only qualified trained personnel should service and repair this equipment.
- Observe local codes and laws and ensure that installation and operation are in accordance with fire, security and safety standards.

Attention:

- *Le cache de l'unité est une partie essentielle du produit. Ne les ouvrez et ne les retirez pas.*
- *N'utilisez jamais l'unité sans que le cache soit en place. L'utilisation de l'unité sans cache présente un risque d'incendie et de choc électrique.*
- *Ne démontez pas l'unité et ne retirez pas ses vis. Aucune pièce se trouvant à l'intérieur de l'unité ne nécessite un entretien par l'utilisateur.*
- *Seul un technicien formé et qualifié est autorisé à entretenir et à réparer cet équipement.*
- *Respectez les codes et réglementations locaux, et assurez-vous que l'installation et l'utilisation sont conformes aux normes contre l'incendie et de sécurité.*



Caution:

- Do not drop the camera or subject it to physical shock.
- Do not touch sensor modules with fingers. If cleaning is necessary, use a clean cloth with a bit of ethanol and wipe it gently. If the camera will not be used for an extended period of time, put on the lens cap to protect the sensor from dirt.
- Do not aim the camera lens at strong light, such as the sun or an incandescent lamp, which can seriously damage the camera.
- Make sure that the surface of the sensor is not exposed to a laser beam, which could burn out the sensor.
- If the camera will be fixed to a ceiling, verify that the ceiling can support more than 112 newtons (112-N) of gravity, or over three times the camera's weight.
- The camera should be packed in its original packing if it is reshipped.



Caution:

To avoid damage from overheating or unit failure, assure that there is sufficient temperature regulation to support the unit's requirements (cooling/heating). Operating temperature should be kept within the range specified by the camera's technical specifications.

Attention:

Afin d'éviter tout dommage dû à une surchauffe ou toute panne de l'unité, assurez-vous que la régulation de température est suffisante pour répondre aux exigences de l'unité (refroidissement/chauffage). La température de fonctionnement doit être maintenue dans l'intervalle spécifié par les spécifications techniques de la camera.

2 Accessing Product Information from the Teledyne FLIR Website

Up-to-date resources for the camera, including the camera's specifications, the Teledyne FLIR Discovery Network Assistant (DNA) software tool, and this guide, are available from the camera's product details and support pages on [the Teledyne FLIR website](https://www.flir.com).

To access product information from the Teledyne FLIR website:

1. Open <https://www.flir.com/browse/security/> and navigate to [Products > Security > Visible Security Cameras](#).

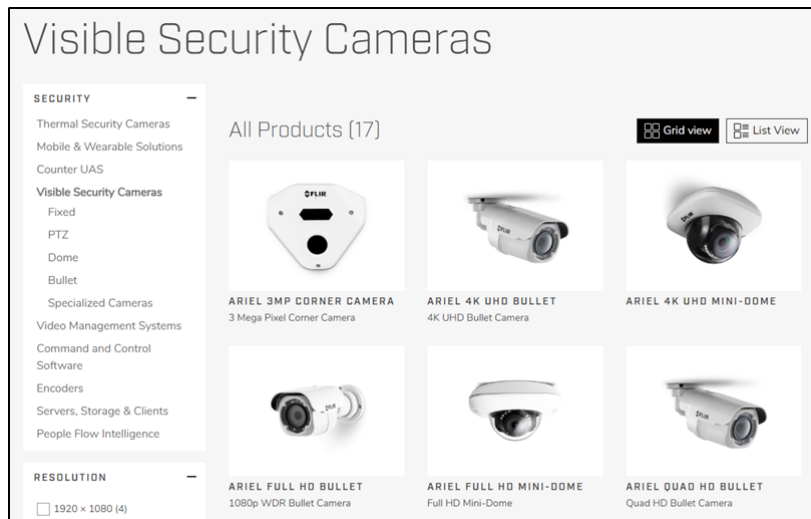

Visible Security Cameras Page on the Teledyne FLIR Website

2. Find and click the camera. The camera's product details page appears.

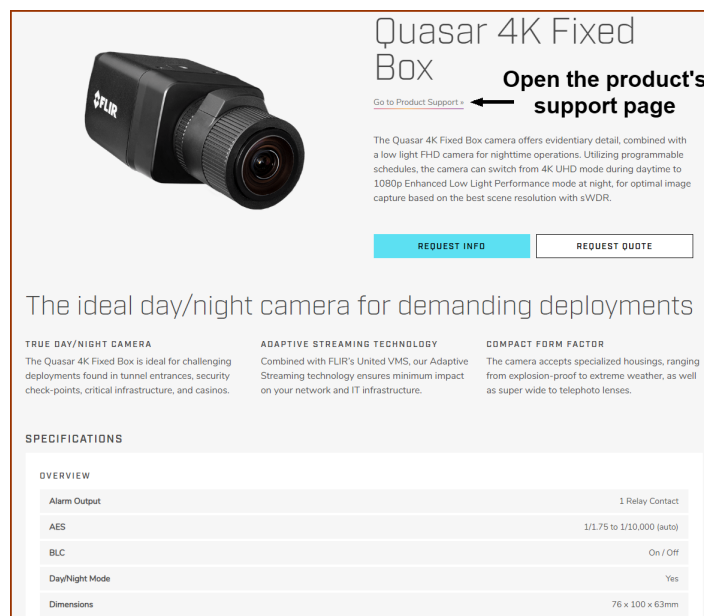

Product Details Page (Example)

To see the camera's specifications and related content, scroll down.

3. Click **Go to Product Support**. The camera's support page appears.
4. Download product documentation from the Documents tab.

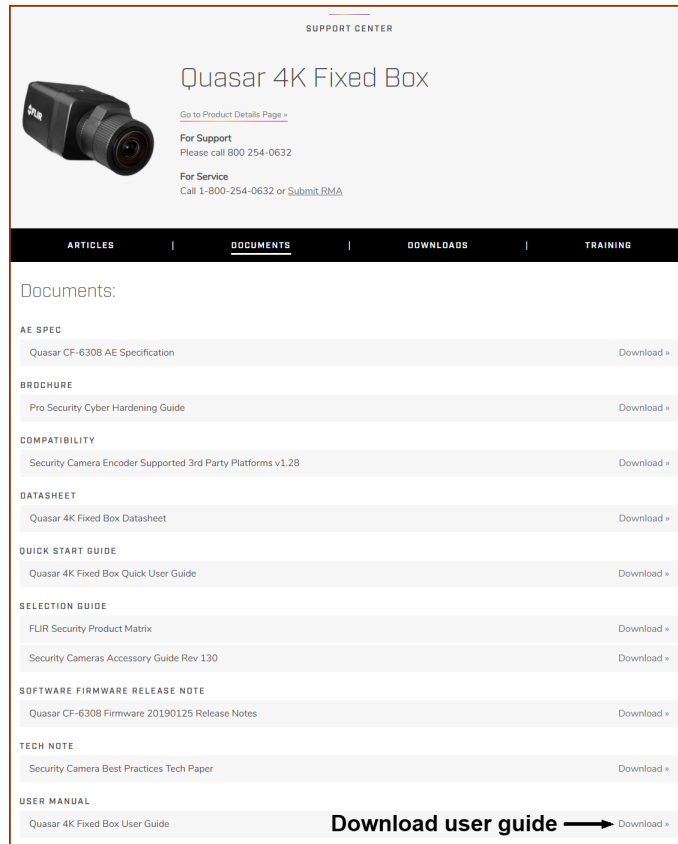

Product Support Page Documents Tab (Example)

5. Download the DNA tool from the Downloads tab.

3 Overview

The Quasar Gen III CP-6302 Range Pan/Tilt/Zoom (PTZ) cameras provide real-time video with high-definition quality at Full HD 1080p. The CP-6302 Range features gyro-based electronic image stabilization, servo feedback for precise preset positioning at frames rates up to 50/60 fps, and True Shutter Wide Dynamic Range at frames rates up to 25/30 fps. With 10x digital zoom, 30x optical zoom, and high-speed PTZ functionality, the Quasar Gen III CP-6302 can quickly cover a wide monitoring area with a high level of detail. The CP-6302-31-I model also features IR illumination up to 200 meters (656 feet)

Up to four streams can be run simultaneously with H.265, H.264 or MJPEG compression, providing an ideal solution when differing levels of image quality are required. The camera can increase frame rate and level of detail when events are triggered. In addition, Teledyne FLIR's adaptive streaming algorithms provide the highest image quality with the lowest bandwidth and storage requirements.



CP-6302-30-R



CP-6302-31-P



CP-6302-31-I

Caution:

If you are using FLIR Latitude VMS, we recommend that you configure the camera's settings via the AdminCenter. This is because the camera's web-based interface might be overwritten by Latitude settings. Refer to the Latitude online help for information regarding configuring camera settings.

Attention:

Si vous utilisez le logiciel de gestion de vidéo Latitude de FLIR, nous vous conseillons de configurer les paramètres de la caméra via l'AdminCenter. En effet, l'interface Internet de la caméra peut être remplacée par les paramètres Latitude. Veuillez consulter l'aide en ligne Latitude pour de plus amples informations sur la configuration des paramètres de la caméra.

3.1 Features

- 10x digital zoom and 30x optical zoom
- Low-lux mode
- Infrared LED illuminator (see Note 1)
- White Balance, Backlight Compensation, and WDR
- Built-in web application/web server
- Two-way audio
- Edge motion detection
- Detection event driven alarms
- FTP upload (up to two locations)
- E-mail SMTP alarm notification (up to two e-mails)
- Sequential snapshot numbering
- ONVIF support
- Security IP restricted access allow/deny list
- UPnP support
- Servo motor for precise positioning and preset location
- 1/2.8" Sony Progressive scan CMOS sensor
- True day/night (ICR)
- IR coverage up to 200m (see Note 1)
- 2DNR/3DNR/ColorNR
- HTTP streaming MJPEG
- 4 alarm input driven events
- Electrical Image Stabilizer
- Remote firmware upgrade
- Upload alarm images to FTP
- Up to 1TB SD / microSDXC card local recording support
- SNMP v1/v2/v3 and SNMP traps
- RTSP support
- Multiple users
- Vandal-proof IP66 enclosure
- Supports PoE++, UPOE, 30VDC, and 24VAC
- Four encoder streams
- PTZ tracking
- IR illumination adjusted by zoom ratio (see Note 1)
- Up to 50/60 fps frame rate
- H.265, H.264 and MJPEG compression
- 2 relay output actions on alarm
- Six exposure modes
- Dual HTTP notification server support (up to two servers)
- Send images on alarm to e-mail
- Record snapshots to local SD / microSDXC card or to NAS on alarm
- 20 privacy masks
- Per-user permissions
- Group permissions
- Built-in heater
- Analog, IP and RS-485 output connections







Notes:

1. Only in IR model

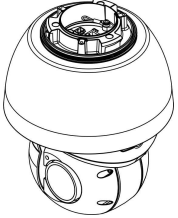
3.2 Package Contents

Before proceeding, check that the box contains the items listed here. If any item is missing or has defects, do not install or operate the product. Contact your dealer for assistance.

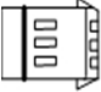
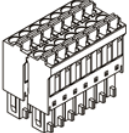
Note: Package Contents vary slightly between models - See Installation Manual.

 <p>Camera Body*</p>	 <p>O-Ring</p>	 <p>Pendant Cap</p>	 <p>Hard Ceiling Mount M4 Screw with Rubber Gasket</p>
 <p>3-Pin 24VAC / 30VDC Power Terminal Block</p>	 <p>14-Pin Alarm/Audio I/O Terminal Block</p>	 <p>Quick Installation Guide</p>	

Package Contents

Notes:

1. CP-6302-30-R is supplied without the upper cover.
2. CP-6302-30-R and CP-6302-31-P are supplied with transparent dome.

See Installation Manual for further details



Note:

The self-tapping screws are mainly for softer substrate/material installation such as wood. For other installation materials such as cement ceilings, it is necessary to pre-drill and use plastic anchors before fastening the supplied self-tapping screws into the wall.

Related Documentation

- *Quasar Gen III CP-6302 Range Installation Manual*
- *Quick Installation Guide (for the relevant CP-6302 model)*
- *DNA User Manual*

3.3 Camera Dimensions

Following are the camera's dimensions.

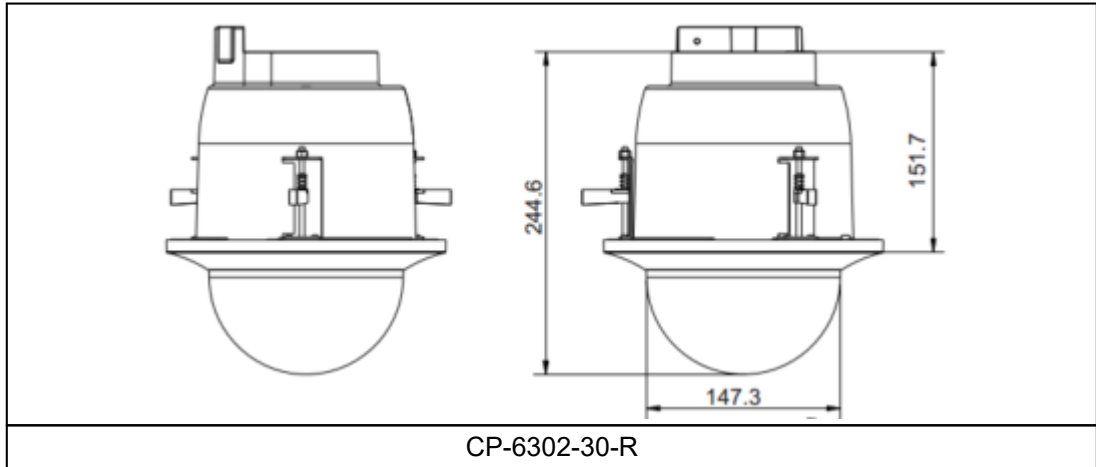

CP-6302-30-R

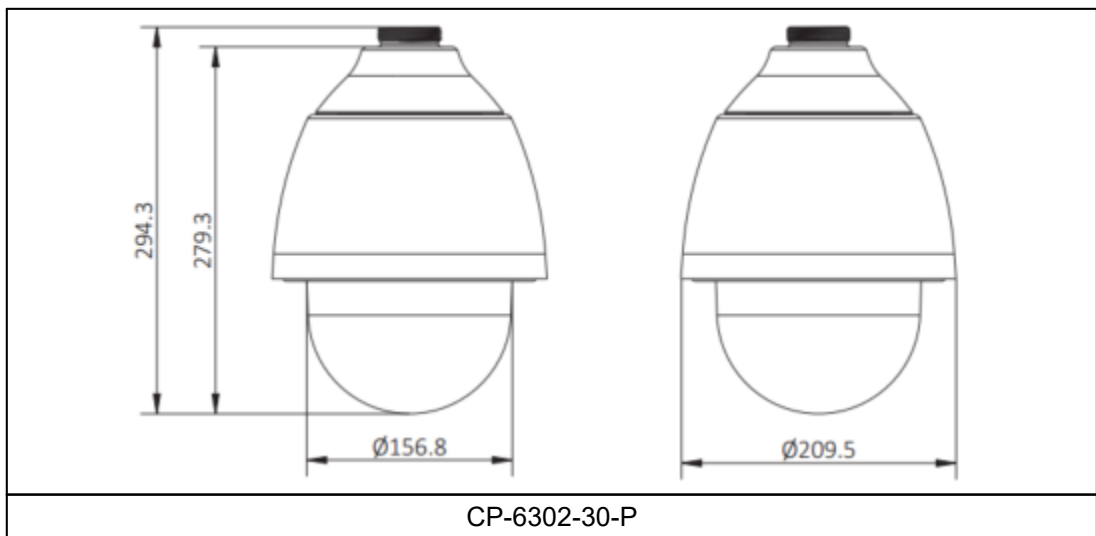

CP-6302-30-P

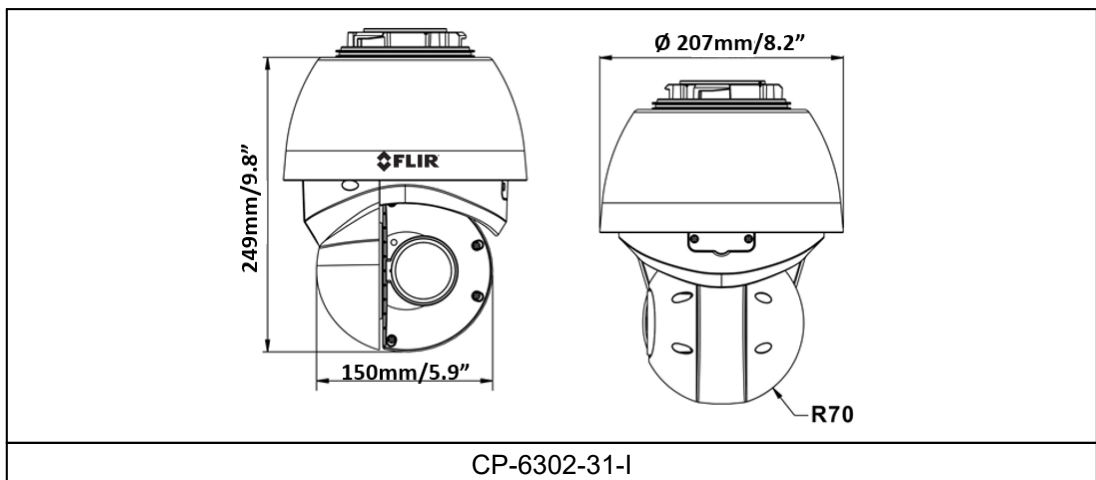

CP-6302-31-I

Notes:

1. The P and R models are supplied with a clear dome.
2. 30R Recessed model has different top cover.

3.4 System Requirements

To access the camera via a web browser, ensure that your PC has the proper network connection and meets system requirements as described below.

Item	Minimum System Requirement
Personal Computer	Minimum: Intel® Core™ i5-2430M, 2.4 GHz; 2GB RAM or more Recommended: Intel® Core™ i7-870, 2.93 GHz; 8GB RAM
Operating System	Windows Server 2012; Windows 7, 8, 8.1, and 10
Web Browser	Microsoft Internet Explorer® 10 and higher (32-bit) with the ActiveX® plug-in; Google Chrome® v.55 and higher; Mozilla Firefox® v.50 and higher; Microsoft Edge® v.38 and above
Network Card	10BaseT (10 Mbps) or 100Base-TX (100 Mbps)

4 Installation

For information about installing a CP-6302 camera and the mounting accessories available, see the *Quasar Gen III CP-6302 Range Installation Manual*.

5 Configuration and Operation

The Quasar Gen III CP-6302 camera is provided with a browser-based configuration interface for video playback and recording. This section includes the following information:

- [Adjusting and Framing-Up the Camera View](#)
- [Browser-Based Viewer Introduction](#)
- [Live Screen](#)
- [System Tab](#)
- [Streaming Tab](#)
- [PTZ Tab](#)
- [Log Out](#)

Additionally, if FLIR Latitude VMS is used, many of the configurations and features of FLIR VMS provide configuration and automation of the camera.

5.1 Adjusting and Framing-Up the Camera View

After the camera is connected to the network and running, it is necessary to frame-up the scene and adjust the camera settings to optimize the picture for the individual scenes. If Latitude is being used, consider scheduling different settings for changing ambient conditions throughout the day, week, month or seasons.

To adjust and frame-up the camera view

1. Make sure the camera is connected to the network on the same VLAN/LAN as the workstation you are going to use to frame-up the scene and adjust the camera settings.
2. Open the camera's browser-based user interface by doing one of the following:

- Open the DNA utility. Run dna.exe or click the

DNA icon . Then, in the DNA Discovery list, double-click the camera or right-click the camera and select Web. Microsoft Internet Explorer opens and the unit's Login dialog box appears.

See the [When using Internet Explorer](#) section below.

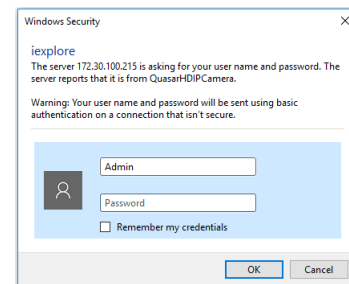

Login Dialog Box (Internet Explorer)

- Use Google Chrome, Mozilla Firefox, or Microsoft Edge to open the camera's browser-based interface. In the browser's address bar, type the camera's IP address.
3. On the login screen, type a user name and the password.

When logging in to the camera for the first time or for the first time after resetting the camera to its factory defaults, the password field appears filled in with hidden characters. However, those characters are empty. Log into the unit with the administrator user name *Admin* and the default password *1234*.

If you do not know the user name or password, contact the person who configured the camera's users and passwords.

4. When logging in to the camera for the first time or for the first time after resetting the camera to its factory defaults, specify a new password for the administrator and then log back in using the new password.



Notes:

- Use strong passwords consisting of at least eight characters and at least one uppercase letter, one lowercase letter, one number, and one special character. The following characters are valid: A-Z, a-z, 0-9, |@#~!\$&<>+_-.,*?=-.
- Passwords are limited to 14 characters and are case-sensitive.

5. After the unit's browser-based interface opens, use the function buttons on the **Live** page to adjust the zoom or focus.



Tip:

To view greater image detail for more accurate high-definition focusing, on the browser-based interface home page, right-click the image, click **Full Screen**, and check the focus.



Notes:

- If you are using Google Chrome, Mozilla Firefox, or Microsoft Edge to access the camera's browser-based user interface, and live video does not appear in the **Live View** window, make sure that *MJPEG* is the *Encode Type* for at least one of the camera's video streams. Check the video stream configuration settings on the [Video Configuration](#) screen, and change if necessary.
- Best focusing results can be achieved when the lens iris is fully open (such as at night in low light). This prevents loss of sharpness if light levels are reduced at night.

When using Internet Explorer

- If the **User Account Control** dialog appears and prompts you to install the ActiveX control `install.cab` file, click **Yes**.

If the ActiveX control does not install, you need to either set the Internet security level to default or change the ActiveX controls and plug-in settings. For instructions, see [Internet Security Settings](#).

- If the message at right appears, your system does not have the required Microsoft Visual C++ 2008 Redistributable libraries.

Download and install the `vc_redist_x86.exe` file from the internet; or contact your Network Administrator or [Teledyne FLIR Support](#).

Installing Ariel Player

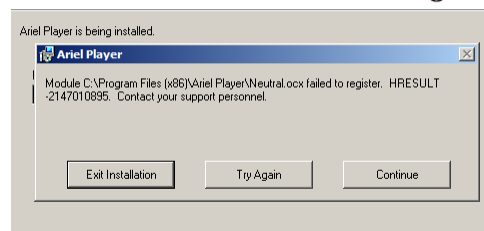

MS Visual C++ 2008 Redistributable Error Message

- If a popup message appears for running the ActiveX add-on, click **Allow**.



Note:

If the password is changed and the Latitude AdminCenter Discovery feature is in use, deselect all other proprietary types. Select "Dvtel Quasar Gen II" for Latitude 7 or "FLIR" and "Auto Select" for Latitude 8 as the Unit Type so that the new password can be configured in the Discovery tab settings.

- Install the Quasar Player. See [Installing and Deleting the Web Player](#).

5.2 Browser-Based Viewer Introduction

The figure below illustrates the camera's user interface when using Internet Explorer. In other browsers, it is similar.

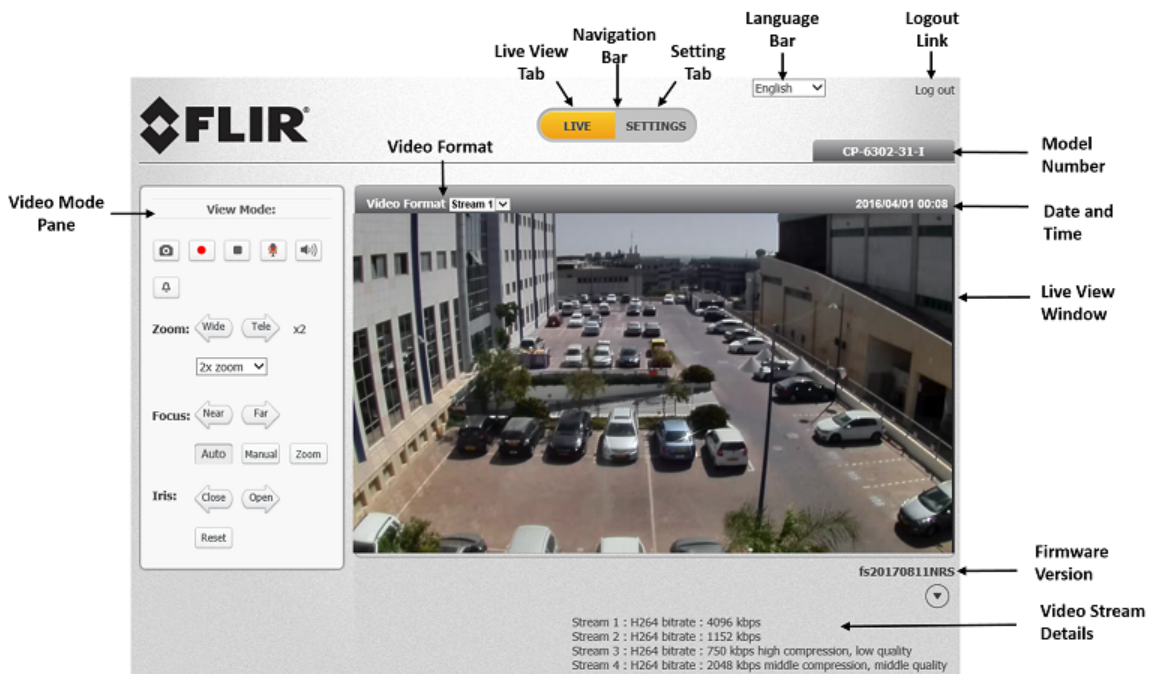

User Interface - Internet Explorer

The user interface displays the following information:

1. The Navigation Bar is displayed in the center of the screen containing Live and Settings buttons.
 - **Live Button**
The **Live** screen opens by default when the camera logs on. It is used to monitor live video of the targeted area, adjust the display size, take snapshots of the view area, stop/start video streaming, record video in a designated file location, activate or de-activate a loudspeaker (audio function), and to perform a digital zoom. An explanation of the items on the screen is included below and in the [Live Screen](#) section.
 - **Settings Button**
Clicking the **Settings** button opens the **Settings** screen, whose sidebar which includes four tabs - **System**, **Streaming**, **Camera**, and **PTZ** – that are used for to configure system settings.
 - **System**
The administrator can configure settings for basic system parameters, security, network operation, events, recording, storage, system maintenance, and more.

- [Streaming](#)
The administrator can modify video and audio settings on this page.
- [Camera](#)
The administrator can adjust many of the camera settings on this page, such as Exposure, Picture Adjustment, Advanced Picture Settings, IR Function, and Miscellaneous settings.
- [PTZ](#)
The administrator can configure all the PTZ settings in this section.

2. The *Language Bar* is displayed to the right of the Navigation Bar. Supported languages include English, German, Spanish, French, Italian, Japanese, Korean, Portuguese, Russian, Simplified Chinese, and Traditional Chinese.
3. The *Log out* link is located to the right of the Language Bar. Click the *Log Out* link to exit the application or log into the camera with a different username and password. See [Log Out](#).
4. The camera *Model Number* is displayed under the *Log out* link.
5. The current *Date and Time* are displayed under the model number.
6. In the center of the interface is the **Live View** window, which displays the image that the camera is monitoring.

If you are using Google Chrome, Mozilla Firefox, or Microsoft Edge and live video does not appear in the **Live View** window, make sure that *MJPEG* is the *Encode Type* for at least one of the camera's video streams. Check the video stream configuration settings on the [Video Configuration](#) screen, and change if necessary.

7. The *Firmware Version* of the camera is displayed under the **Live View** window on the right side.
8. The *Video Stream Details* are displayed under the Firmware Version.
9. The *Video Format* is displayed and can be selected to the left of the *Date and Time*.
10. The *View Mode* pane to the left of the **Live View** window contains function buttons which facilitate camera control. This pane is discussed in the following section.

5.3 Live Screen

The camera's **Live** screen is used to monitor live video. See [Browser-Based Viewer Introduction](#). Double-clicking the Live window opens the **Info** dialog box, which displays key details about the video stream:

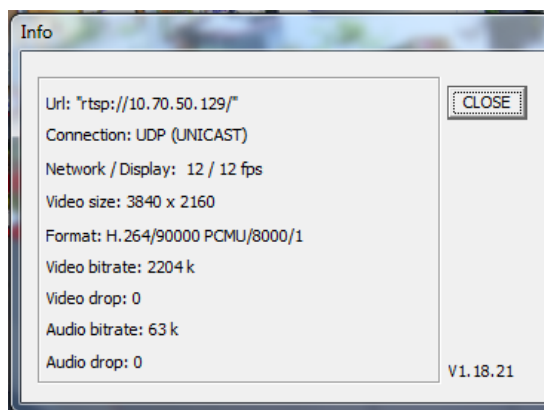

Live Video Info Dialog Box

Two viewing modes are available: Fullscreen and Center Mode.

To view the Live View screen in Fullscreen mode

1. Right-click the screen.
2. Click **Fullscreen**. The image is displayed in the entire monitor screen.

To exit Fullscreen mode

1. Do one of the following:
 - a. Press the Escape key on your keyboard. The **Live View** screen is displayed in the monitor screen.
 - b. Right-click the screen.
 - i. Click **Normal view**. The **Live View** screen is displayed in the monitor screen.

To view the Live View screen in Center mode

1. Right-click the screen.
2. Click **Set center mode**. The camera automatically centers on the crosshair location.
3. Click **Set emulated joystick mode** to return to the normal viewing mode. In this mode, the PTZ controls emulate a joystick (default mode).

View Mode Pane

The View Mode pane includes buttons that enable convenient camera control from the **Live** screen.

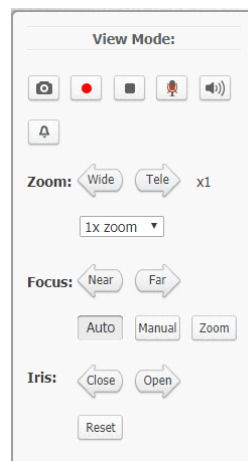

View Mode Pane

The *View Mode* pane includes the following function buttons:



The **Microphone** button allows the local site to talk to the remote site. Click the button to switch it on/off. This function is available only to a user who has been granted this privilege by the Administrator. Refer to [User](#) in the Security section for further details.



Click the **Speaker** button to mute/activate the audio. This function is available only to a user who has been granted this privilege by the Administrator. Refer to [User](#) in the Security section for further details.



Click this button to automatically save the JPEG snapshots in the specified location. The default location to save snapshots is: C:\. To change the storage location, refer to [File Location](#).

Video Streaming Restart/Stop 



Press the **Stop** button to disable video streaming and to display the live video as black. Press **Restart** to show the live video again.

Record/Pause 

Pressing the **Recording** button stores recordings from the Live View in the location specified on the local hard drive, which can be configured in the **File Location** screen. The default storage location for the web recording is: C:/. Refer to [File Location](#) for details.

Zoom: Wide/Tele   

Press the **Tele** or **Wide** button to control zoom in/out, or move the zoom adjustment bar to the desired zoom ratio. The range is from x1 to x30 and is displayed next to the zoom bar. The default is 1x.

Focus: Auto/Manual/Near/Far    

Press the **Near** or **Far** button to implement continuous focus adjustment.

Following is an explanation of the function buttons listed above:

- **Optical/Digital Zoom Control**
 In Normal View display mode, you can zoom in/out by moving the cursor to the Live Video pane and scrolling the mouse wheel. Digital zoom is only available when the function is activated and set up on the [Camera > Misc](#) screen. When the camera reaches the limit of its optical range, it automatically switches to digital zoom.
- **Focus Adjustment**
 - Auto Focus (Continuous AF) – Click the **Auto** button to enable AF mode. In this mode, the camera automatically and continuously maintains focus regardless of zoom or view changes.
 - Manual Focus – Click the **Manual** button to adjust focus manually using the **Near** and **Far** buttons.
 - Zoom – Clicking the **Zoom** button causes the camera to focus when the zoom changes.

An additional function button is located under the **Live View** window:

Display/Hide PT Controls  

Press the **Arrow Up** button to display the PT (Pan/Tilt) control panel. Press the **Arrow Down** button to hide the PT control panel. The following controls are available:



PT Control Panel

- Use the PT control panel to move the camera and to run Presets, Pattern lines, and Sequence paths.
- Select a Preset/Pattern/Sequence line.
 - Preset - Select a number from 1-10 from the drop-down menu. Click [here](#) for details about this function.
 - Pattern - Select a number from 1-8 from the drop-down menu. Click [here](#) for details about this function.
 - Sequence - Select a number from 1-8 from the drop-down menu. Click [here](#) for details about this function.
- To stop running a Pattern or Sequence path, move the cursor to the Live View pane and move the camera in any direction.
- The PT Speed setting controls the rate at which the pan and tilt changes. Set a number between 1 and 10 as the PT Speed every time users pan or tilt the camera via the PT control panel.

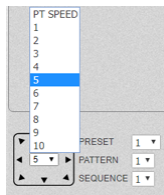

PT Speed Drop-Down Menu

- **Live View Pane Pan/Tilt Control (Internet Explorer only)**
Control pan/tilt by left-clicking the cursor in the Live View pane and dragging the pointer in any direction. Placing the pointer close to the center of the image results in a slow rate of change. Placing the pointer further from the center results in a more rapid rate of change.

Fullscreen Mode



Click this button to view the monitored image in full screen mode when using Digital Zoom Control. Use the mouse to control zoom effects in Full Screen mode: scroll the mouse wheel (for zoom in/out), and drag the mouse into any direction. Double-click on the screen to exit Full Screen mode and return to the Home page.

5.4 System Tab

The **Settings** tab in the Navigation Bar opens the sections in the sidebar that are used for configuring the camera. It opens on the **System** section, which includes the following tabs:

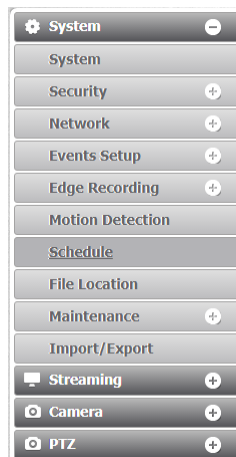

System Section Tabs

Details of these settings are specified in the following sections:

- [System](#) [Security](#) [Network](#) [Events Setup](#) [Edge Recording](#)
[Motion Detection](#) [Schedule](#) [File Location](#) [Maintenance](#) [Import/Export](#)



Note:
The **System** screen is accessible only by the Administrator.

5.4.1 System

The **System** screen is used for entering the camera's friendly name and date and time settings. Click the **System** tab in the sidebar. The **System** screen is displayed.

System Screen

The **System** screen includes the following fields:

Host Name

The host name is for camera identification. If the alarm function is enabled and is set to send an alarm message by Mail or FTP, the host name entered here is displayed in the alarm message.

Time Zone

Select the time zone from the drop-down menu.

Enable Daylight Saving Time

To enable daylight saving time, check the box and then specify time offset (number of hours or minutes difference between daylight saving time and standard time), start date and time for daylight saving time, and end date and time for daylight saving time. The format for time offset is [hh:mm:ss]. For example, if the amount of time offset is one hour, enter 01:00:00 in the field.

Time format

Enables a choice of formats: either year, month and day (yyyy/mm/dd) or day, month and year (dd/mm/yyyy).

Sync with Computer Time

Select this button to synchronize video date and time display with the PC. You can change the PC date and time in the respective text box.

Manual

The Administrator can set video date and time manually. Entry format should be identical with that displayed to the right of the text box.

Sync with NTP Server

Network Time Protocol (NTP) is an alternate way to synchronize the camera's clock with an NTP server. Enter the network time server host name or IP address to synchronize in the text box. Then select an update interval (every hour, day or week) from the drop-down menu. For further information about NTP, visit www.ntp.org.

Click **SAVE** when finished.

5.4.2 Security

Clicking the **Security** tab in the **System** sidebar opens a drop-down menu with the following screens:

[User](#) [HTTPS](#) [IP Filter](#) [IEEE 802.1X](#)

5.4.2.1 User

The **User** screen is used for entering and managing user credentials and privileges, as well as configuring authentication settings.

User Screen

**Notes:**

- Use strong passwords consisting of at least eight characters and at least one uppercase letter, one lowercase letter, one number, and one special character. The following characters are valid: A-Z, a-z, 0-9, |@#~!\$&<>+ _-,*?=.
- User names and passwords are limited to 14 characters and are case-sensitive.
- When the camera is in its default state, the hidden characters that appear in the password fields are empty. Type in the passwords.

Admin Password

Change the administrator's password by entering the new password in both text boxes. For security, the password characters are hidden. After clicking **SAVE**, type in the new password for the administrator.

Add user

There is a maximum of 20 user accounts.

To add a new user

1. Type the new user name and password in the respective fields.
2. Select the appropriate check boxes to give the user Camera Control, Talk and Listen permissions.
 - *I/O access* – Basic functions that enable you to view video when accessing to the camera.
 - *Camera control* – Allows you to change camera parameters on the **Camera** tab.
 - *Talk* – *Talk* allows the user at the local site to talk from the remote site to the administrator
 - *Listen* – *Listen* allows the user at the local site to listen from the remote site to the administrator.
3. Click **ADD**.

Manage User

- To delete a user, select the *User name* drop-down list and select the user. Click **DELETE** to remove the user.
- To edit a user, select the *User name* drop-down list and select the user. Click **EDIT** to edit the user's password and privileges.

**Note:**

You must enter the user password and also select the authorized function(s).

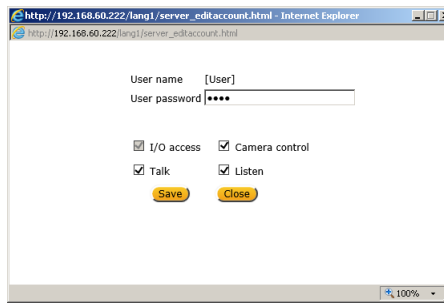

Edit User Account Dialog Box

- Click **Save** to modify the account credentials and privileges, or **Close** to discard changes.

HTTP Authentication Setting

From the drop-down list, select one of the following options:

- *Basic* – A form of authentication that uses unencrypted base64 encoding. Basic Authentication should generally only be used where transport layer security, such as HTTPS, is provided.
- *Digest* – A form of authentication used over RTSP in which credentials are encrypted when transmitted.

Click **SAVE**.

Streaming Authentication Setting

From the drop-down list, select one of the following options:

- *Disable* – Do not use streaming authentication (default setting).
- *Basic* – A form of authentication that uses unencrypted base64 encoding. Basic Authentication should generally only be used where transport layer security, such as HTTPS, is provided.
- *Digest* – A form of authentication used over RTSP in which credentials are encrypted when transmitted.

Click **SAVE**.

5.4.2.2 HTTPS

To use HTTPS on the camera, an HTTPS certificate must be installed. The HTTPS certificate can be obtained either by creating and sending a certificate request to a Certificate Authority (CA) or by creating a self-signed HTTPS certificate as described below.



Note:

The self-signed certificate does not provide the same level of security as a CA-issued certificate.

HTTPS allows secure connections between the camera and web browser using Secure Socket Layer (SSL) or Transport Layer Security (TLS) to protect camera settings and username/password info. A self-signed certificate or a CA-signed certificate is required to implement HTTPS.

To create a self-signed certificate

Before a CA-issued certificate is obtained, users can first create and install a self-signed certificate. Under the **Security** category, click the **HTTPS** tab in the sidebar.

1. On the **HTTPS** page, click **CREATE** under *Create Self-Signed Certificate*. The **Create Self-Signed Certificate** dialog box opens.

Create Self-Signed Certificate Request Dialog Box

2. Enter the information in the appropriate field. A definition of each of the required fields follows.
 - *Country* – Enter a two-letter combination code to indicate the specific country in which the certificate will be used. For instance, type “US” to indicate United States.
 - *State or province* – Enter the local administrative region.
 - *Locality* – Enter other geographical information.
 - *Organization* – Enter the name of the organization to which the entity identified in *Common Name* belongs.
 - *Organizational Unit* – Enter the name of the organizational unit to which the entity identified in the *Common Name* field belongs.
 - *Common Name* – Indicate the name of the person or other entity that the certificate identifies (often used to identify the website).
 - *Valid days* – Enter the period in days (1 ~ 9999) to indicate the valid period of certificate.
3. Click **OK** to save the certificate request after completion. The details are displayed in the *Subject* field of the *Installed Certificate* section.
4. To view the details of the Installed Certificate, click **PROPERTIES**. The details are displayed in the **Certificate Properties** dialog box. If you want to remove the certificate, click **REMOVE**.
5. When the signed certificate is returned from the CA, click **Browse** in the *Install Signed Certificate* section to locate the file.
6. Click **UPLOAD** to install the certificate.

To create a certificate request

1. Click **Create Certificate Request** to create and submit a certificate request in order to obtain a signed certificate from a CA. The **Create Certificate Request** dialog box opens.

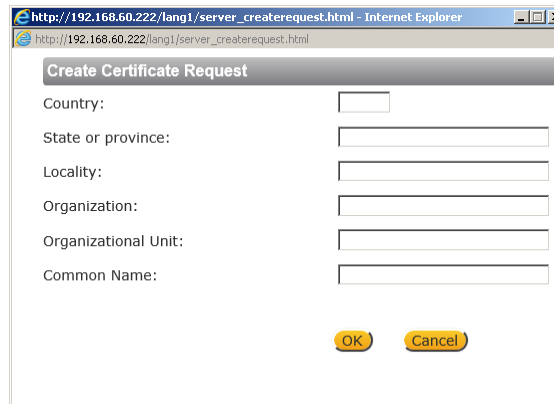

Create Certificate Request Dialog Box

2. Enter the information in the appropriate field. A definition of each of the required fields follows.
 - *Country* – Enter a two-letter combination code to indicate the specific country in which the certificate will be used. For instance, type “US” to indicate United States.
 - *State or province* – Enter the local administrative region.
 - *Locality* – Enter other geographical information.
 - *Organization* – Enter the name of the organization to which the entity identified in Common Name belongs.
 - *Organizational Unit* – Enter the name of the organizational unit to which the entity identified in the Common Name field belongs.
 - *Common Name* – Indicate the name of the person or other entity that the certificate identifies (often used to identify the website).
3. Click **OK** to save the details of the certificate request after completion. When the request is complete, the subject of the Created Request is displayed in the Subject field.
4. To view details of the Certificate Request, click **PROPERTIES** below the *Subject* field. The **Certificate Request Properties** dialog box opens. If you want to remove the certificate, click **REMOVE**.
5. Copy the PEM-formatted request and send it to your CA.



Note:

The self-signed certificate does not provide the same level of security as a CA-issued certificate.

5.4.2.3 IP Filter

The IP filter restricts access to the camera by denying/allowing specific IP addresses. Click the **IP Filter** tab under the category **Security** in the sidebar to display the following page.

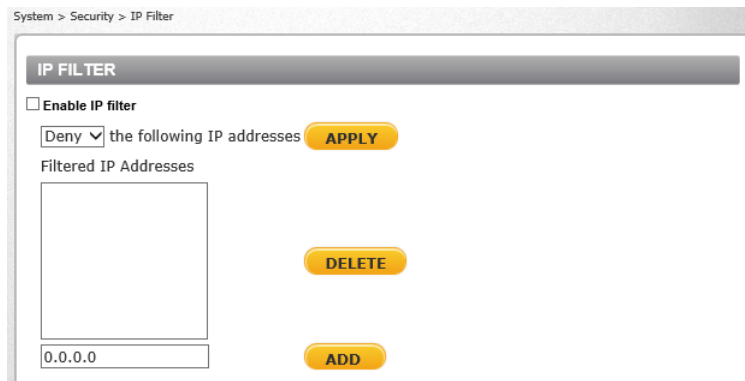

IP Filter Screen

To enable the IP filter

1. Check the box to enable the IP filter function. Once enabled, the listed IP addresses (IPv4) are allowed or denied access to the camera.
2. Select *Allow* or *Deny* from the drop-down list. The default setting is *Deny*.
3. Click **APPLY** to determine the IP filter behavior.

To add or delete an IP address

1. Enter the IP address in the *Filtered IP Addresses* text box.
2. Click **ADD** to add a new filtered address. The *Filtered IP Addresses* box shows the currently configured IP addresses. Up to 256 IP address entries may be specified.
3. To remove an IP address from the list, select the IP address and then click **DELETE**.

5.4.2.4 IEEE 802.1X

The camera is allowed to access a network protected by 802.1X/EAPOL (Extensible Authentication Protocol over LAN). Users must contact the network administrator to obtain certificates, user IDs, and passwords.

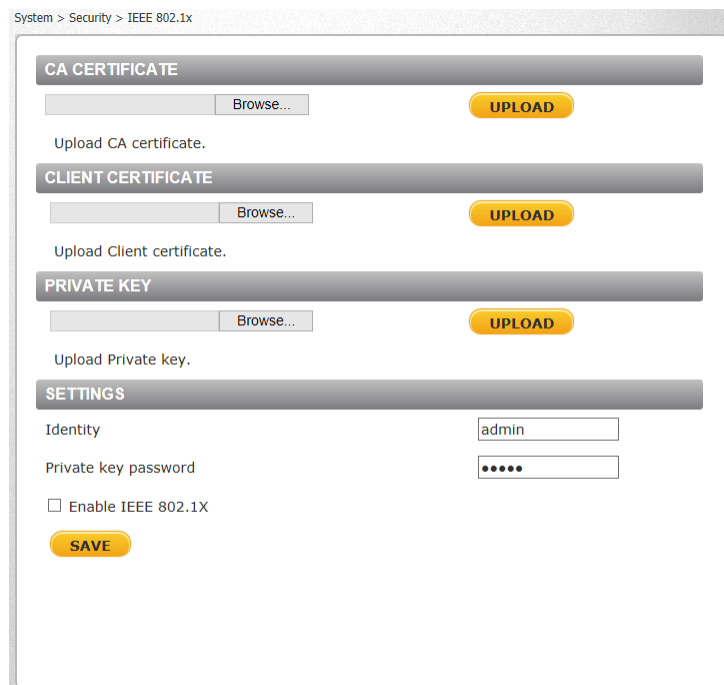

IEEE 802.1X/EAP-TLS Screen

CA Certificate

The CA certificate is created by the Certificate Authority for the purpose of validating itself. Click **Browse** to locate the file and **UPLOAD** to upload the certificate to check the server's identity.

Client Certificate

Upload the Client Certificate to authenticate the camera. Click **Browse** to locate the file and **UPLOAD** to upload the certificate.

Private Key

Upload the Private Key to authenticate the camera. Click **Browse** to locate the file and **UPLOAD** to upload the private key.

Settings

- *Identity* – Enter the user identity (user name) associated with the certificate. Up to 16 characters can be used.
- *Private Key Password* – Enter the password associated with the user identity. Up to 16 characters can be used.
- *Enable IEEE 802.1X* – Select the checkbox to enable IEEE 802.1X security. The setting is disabled by default.

When the camera is in its default state, the hidden characters that appear in the password fields are empty. Type in the passwords.

Click **SAVE** to save the IEEE 802.1X/EAPTLS setting.

5.4.3 Network

From the **System** screen, click the **Network** tab. The following screens are available:

[Basic](#)

[QoS](#)

[SNMP](#)

[UPnP](#)

[DDNS](#)

[Mail](#)

[FTP](#)

[HTTP](#)

5.4.3.1 Basic

The **Basic** screen is used to configure the camera's basic network settings.

Network > Basic Screen

It is possible to connect to the camera with either fixed or dynamic (DHCP) IP address. The camera also provides PPPoE (Point-to-Point Protocol over Ethernet) support for users who connect to the network via PPPoE.

The **Basic** screen is divided into three sections: *General*, *Advanced* and *IPv6 Configuration*.

General

Select one of the following options in the *General* area for configuring network settings:

- *Get IP address automatically*
- *Use fixed IP address*
- *Use PPPoE*

Get IP address automatically

If you select *Get IP address automatically*, to obtain the IP address from a DHCP server on the network, you can use the DNA utility, which can be downloaded from [the product's pages on the Teledyne FLIR website](#). See Accessing Camera Information from the Web and the Using DNA to Access the Camera topic in the *Quasar Gen III CP-6302 Range Installation Manual*.

**Note:**

For future reference, record the camera's MAC address, which is found on the camera label.

Use fixed IP address

The camera's default setting is *Use fixed IP address*. For information about how to log in with the default IP address, see the Using DNA to Access the Camera topic in the *Quasar Gen III CP-6302 Range Installation Manual*. You may use DNA or enter the IP address in your Internet browser's URL address bar.

To set up a new static IP address

1. Select the *Use fixed IP address* option.
2. Enter the following information:
 - *IP address* – The IP address is necessary for network identification.
 - *Subnet mask* – Used to determine if the destination is in the same subnet. The default value is 255.255.255.0.
 - *Default gateway* – Used to forward frames to destinations in a different subnet. An invalid gateway setting causes transmission to destinations in other subnets to fail.
 - *Primary DNS* – The primary domain name server that translates host names into IP addresses.
 - *Secondary DNS* – A secondary domain name server that backs up the primary DNS.

Use PPPoE

If you wish to use PPPoE to configure network settings, select the *Use PPPoE* radial button.

To use PPPoE

1. Enter your PPPoE user name and password into the respective fields.
When the camera is in its default state, the hidden characters that appear in the password field are empty. Type in the password.
2. Click **SAVE** to confirm the settings.

Advanced

Enter the following advanced parameters in the *Advanced* section of the screen:

- *Web Server port* – The default web server port is 80. Once the port is changed, the user must be notified the change for the connection to be successful. For instance, when the Administrator changes the HTTP port of the camera whose IP address is 192.168.0.100 from 80 to 8080, the user must type in the web browser `http://192.168.0.100:8080` instead of `http://192.168.0.100`.
- *RTSP port* – The default setting of the RTSP port is 554. The range is from 1024 to 65535.
- *MJPEG over HTTP port* – The default setting of MJPEG over HTTP port is 8008. The range is from 1024 to 65535.
- *HTTPS port* – The default setting of HTTPS port is 443. The range is from 1024 to 65535.
- *MTU* – The MTU (Maximum Transmission Unit) is the greatest amount of data that can be transferred in one physical frame on the network. For Ethernet, the MTU is 1500 bytes (default setting). For PPPoE, the MTU is 1492. The range is from 1200 to 1500 bytes.
- *RTSP URL* – Enter a friendly name for each stream in the text box.

**Note:**

Be sure to assign a different port number for each service mentioned above.

Click **SAVE** when finished.

IPv6 Address Configuration

To enable IPv6

1. Check *Enable IPv6*.
2. In the *Address* text box, enter the unit's IPv6 IP Address.

5.4.3.2 QoS

QoS (Quality of Service) provides differentiated service levels for different types of traffic packets and guarantees delivery of priority services during periods of network congestion. Adapting the Differentiated Services (DiffServ) model, traffic flows are classified and marked with DSCP (DiffServ Code point) values, and as a result receive the corresponding forwarding treatment from DiffServ-capable routers. DSCP configuration settings are entered in the **System > Network > QOS** screen:

The screenshot shows a web interface for configuring QoS settings. The breadcrumb path is "System > Network > QoS". The main heading is "DSCP SETTINGS". Below this, there are three input fields: "Video DSCP" with a value of 0, "Audio DSCP" with a value of 0, and "Management DSCP" with a value of 0. A yellow "SAVE" button is located at the bottom left of the form area.

QoS Screen

DSCP Settings

The DSCP value range is from 0 to 63. The default DSCP value is 0 (DSCP disabled). The camera uses the following QoS classes: Video, Audio, and Management.

- *Video DSCP* – This class consists of applications such as MJPEG over HTTP, RTP/RTSP and RTSP/HTTP.
- *Audio DSCP* – The camera supports audio.
- *Management DSCP* – This class consists of HTTP traffic (web browsing).

Click **SAVE** when finished.

**Note:**

To enable this function, make sure the switches/routers in the network support QoS.

5.4.3.3 SNMP

The Simple Network Management Protocol (SNMP) enables the camera to be monitored and managed remotely by the network management system. SNMP configuration settings are entered in the **System > Network > SNMP** screen.

SNMP Settings Screen

SNMP v1/v2

- *Enable SNMP v1* or *Enable SNMP v2* – Select the version of SNMP (v1 or v2) to use by checking the relevant box.
- *Read Community* – Specify the community name that has read-only access to all supported SNMP objects. The default value is *public*.
- *Write Community* – Specify the community name that has read/write access to all supported SNMP objects (except read-only objects). The default value is *private*.

SNMP v3

SNMP v3 provides important security features including:

- Confidentiality – Encryption of packets to prevent snooping by an unauthorized source.
- Integrity – Message integrity to ensure that a packet has not been tampered with in transit including an optional packet replay protection mechanism.
- Authentication – To verify that the message is from a valid source.

To enable the SNMP v3 protocol, enter the appropriate data and passwords requested:

- *Enable SNMP v3* – Select the checkbox.
- *Security Name* – See note below.
- *Authentication Type* – Select *MD5* or *SHA* from the drop-down list. The default setting is *MD5*. See note below.
- *Authentication Password* – See note below.
- *Encryption Type* – Select *DES* or *AES* from the drop-down list. The default setting is *DES*. See note below.
- *Encryption Password* – See note below.



Notes:

- You may have to consult with your System Administrator to activate this function.
- When the camera is in its default state, the hidden characters that appear in the password fields are empty. Type in the passwords.

Traps for SNMP v1/v2/v3

Traps are used by the camera to send messages to a management system for important events or status changes.

- *Enable traps* – Check this box to activate trap reporting.
 - *Trap address* – Enter the IP address of the management server.
 - *Trap community* – Enter the community to use when sending a trap message to the management system. The default value is *public*.
- Trap Option
 - *Warm start* – A warm start SNMP trap signifies that the SNMP device, such as the camera, performs a software reload.

Click **SAVE** when finished.

5.4.3.4 UPnP

The **System > Network > UPnP** screen enables the Universal Plug-and-Play protocol on your network devices.



UPnP Screen

UPnP Settings

- *Enable UPnP* – If UPnP is enabled and a camera is discovered on the LAN, the icon of the connected camera appears in My Network Places, allowing direct access, as seen below.

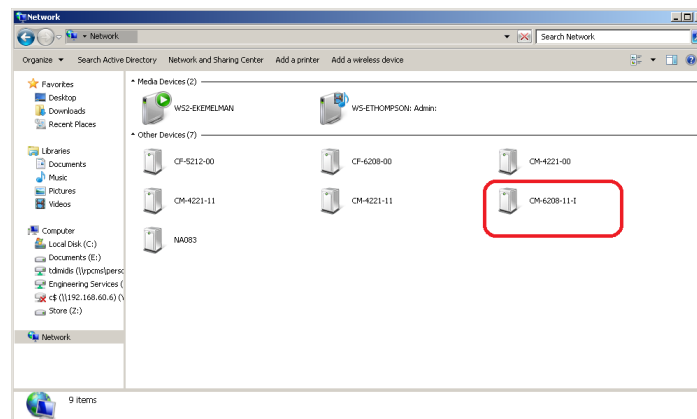

Direct Access to Camera with UPnP Enabled

 **Note:**
 To enable this function, make sure the UPnP component is installed on your computer. Refer to [Install UPnP Components](#) for the Windows 7, 8, 8.1, and 10 procedure.

- *Enable UPnP port forwarding* – When UPnP port forwarding is enabled, the camera is allowed to open the web server port on the router automatically.

 **Note:**
 To enable this function, make sure that your router supports UPnP and that it is activated.

- *Friendly name* – Enter the name for the camera for identification.

Click **SAVE** when finished.

5.4.3.5 DDNS

Dynamic Domain Name System (DDNS) allows a host name to be constantly synchronized with a dynamic IP address. This permits those using a dynamic IP address to be accessed by a static domain name. DDNS configuration settings are entered in the **System > Network > DDNS** screen:

DDNS Screen

To use DDNS

1. Select the *Enable DDNS* checkbox.
2. From the *Provider* drop-down list, select a DDNS host provider name. The default setting is *DynDNS.org (Dynamic)*.
3. In the *Host name* text box, enter the registered domain name.

4. In the *Username/E-mail* text box, enter the username or e-mail address required by the DDNS provider for authentication.
5. In the *Password/Key* text box, enter the password or key required by the DDNS provider for authentication.

When the camera is in its default state, the hidden characters that appear in the password field are empty. Type in the password.

6. Click **SAVE** when finished.

5.4.3.6 Mail

Simple Mail Transfer Protocol (SMTP) is a protocol for sending e-mail messages between servers. It is a relatively simple, text-based protocol, where a text message is transferred to one or more specified recipients. The Administrator can send an e-mail via Simple Mail Transfer Protocol (SMTP) when an alarm is triggered. E-mail notifications are set by selecting the checkbox for an e-mail-related triggered action on the [IO](#), [Network Failure Detection](#), and [Motion Detection](#) screens.

SMTP (E-mail) server configuration settings are entered in the **System > Network > Mail** screen:

Mail Screen – SMTP

Two SMTP server accounts can be configured with or without SSL encryption. Enter the settings for the 1st SMTP server and 2nd SMTP server in the appropriate fields. Settings include SMTP server, server port (the default port is 25), account name, password, and recipient e-mail address settings. To encrypt e-mail with SSL, select the 1st SMTP SSL and/or 2nd SMTP SSL checkbox. For SMTP server details, contact your network service provider.

When the camera is in its default state, the hidden characters that appear in the password fields are empty. Type in the passwords.

Click **SAVE** when finished.

5.4.3.7 FTP

The Administrator can send an alarm message to one or two File Transfer Protocol (FTP) sites when motion is detected. FTP notifications are set by selecting the checkbox for an FTP-related triggered action on the [IO](#), [Network Failure Detection](#), and [Motion Detection](#) screens.

For each server, enter the server IP address, server port number, user name, password, and remote folder path. Settings are entered in the **System > Network > FTP** screen:

System > Network > FTP

FTP

1st FTP server

1st FTP server port

1st FTP user name

1st FTP password

1st FTP remote folder

1st FTP passive mode

2nd FTP server

2nd FTP server port

2nd FTP user name

2nd FTP password

2nd FTP remote folder

2nd FTP passive mode

SAVE

FTP Screen

When the camera is in its default state, the hidden characters that appear in the password fields are empty. Type in the passwords.

To use passive mode, select the *1st FTP passive mode* or *2nd FTP passive mode* checkbox for the respective server. In passive mode, FTP the client initiates both connections to the server, solving the problem of firewalls filtering the incoming data port connection to the client from the server.

In order to support passive mode FTP on the server-side firewall, the following communication channels must be opened:

- FTP server's port 21 from anywhere (client initiates connection)
- FTP server's port 21 to ports > 1023 (server responds to client's control port)
- FTP server's ports > 1023 from anywhere (client initiates data connection to random port specified by server)
- FTP server's ports > 1023 to remote ports > 1023 (server sends ACKs and data to client's data port)

Click **SAVE** when finished.

5.4.3.8 HTTP

An HTTP notification server detects notification messages of triggered events sent from cameras. HTTP notifications are set by selecting the *Send HTTP notification* checkbox on the [Motion Detection](#) screen.

Two notification server accounts (Alarm Triggered and Motion Detection) can be set up and sent to the specified HTTP servers. For each server, enter the HTTP details, including server IP address, user name, and password. Settings are entered in the **System > Network > HTTP** screen:

HTTP Screen

When the camera is in its default state, the hidden characters that appear in the password fields are empty. Type in the passwords.

Click **SAVE** when finished.

5.4.4 Events Setup

The **Events Setup** tab is used for configuring general settings related to event notification. It includes the following screens:

[IO](#) [Network Failure Detection](#) [Periodic Event](#) [Manual Trigger](#) [Audio Detection](#) [Tampering](#)

5.4.4.1 IO

The **IO** screen is used to control input and output alarms and messages, which are generated when an event is recognized by the system.

IO Screen

Alarm Switch

Four alarms are available. For each alarm, the Administrator can select from the following options:

- Select *Off* to disable an alarm.
- Select *On* to enable an alarm (default setting).
- Select *By Schedule* to set a schedule. Then click *Please Select* to select up to 10 schedules from the drop-down list that opens. The selected schedules are displayed in the *Please Select* text box. To set a schedule, open the [Schedule](#) tab.

Click **SAVE** after configuring the settings.

Alarm Type

Select an alarm type (*Normal close* or *Normal open*) that corresponds to the alarm application. *Normal open* is the default setting. Click **SAVE** after configuring the settings.

Alarm Output

Define the normal alarm output signal as *Output high* or *Output low*, according to the current alarm application. The default setting is *high*. Click **SAVE** after configuring the settings.

Triggered Action

The Administrator can specify various alarm actions to take when an alarm is triggered. See the [Triggered Actions](#) section for a detailed description of the actions. The following options are available:

- *Enable alarm output 1* – Check this box and select the predefined type of alarm output (*low* or *high*) to enable alarm relay when a network failure is detected.
- *Enable alarm output 2* – Check this box and select the predefined type of alarm output (*low* or *high*) to enable alarm relay when a network failure is detected.
- *Send Message by FTP* – The Administrator can select whether to send an alarm message by FTP when an alarm is triggered.
- *Send message by E-Mail* – The Administrator can select whether to send an alarm message by e-mail when an alarm is triggered.
- *Upload Image by FTP* – Selecting this option enables you to assign an FTP site and configure various parameters.

- **Upload image by E-Mail** – Select this checkbox to assign an e-mail address for sending the image captured by a triggered alarm. The e-mail address is entered in the [Mail](#) screen.
- **Send HTTP notification** – Select this checkbox to send a notification by HTTP.
- **Record video clip** – Select this box in order to save the alarm-triggered recording to the local SD / microSDXC card or to the NAS.
- **PTZ Function** – Select this checkbox to set a Preset, Sequence, Auto Pan, or Pattern; Function line; or Dwell time. These functions can be configured in more detail from the [Settings > PTZ](#) tab.

Click **SAVE** after configuring the settings.

File Name

- **File Name** – Enter a file name in the field, for example *image.jpg*. The uploaded image's file name format is set in this section. Select one that meets your requirements.
- **Add date/time suffix (default setting)**
File name: imageYYMMDD_HHNNSS_XX.jpg
Y: Year, M: Month, D: Day
H: Hour, N: Minute, S: Second
X: Sequence Number
- **Add sequence number suffix (no maximum value)**
File name: imageXXXXXXXX.jpg
X: Sequence Number
- **Add sequence number suffix (limited value)**
File Name: imageXX.jpg
X: Sequence Number

The file name suffix ends at the number being set. For example, if the setting is up to “10,” the file name will start from 00, end at 10, and then start over again.

- **Overwrite**
The original image in the FTP site will be overwritten by the new uploaded file with a static filename.

Click **SAVE** after configuring the settings.

5.4.4.2 Network Failure Detection

Settings on the **Network Failure Detection** screen enable the camera to periodically ping another IP device within the network to detect a network failure, for example, if a video server is disconnected. By implementing local recording through an SD or microSDXC card, the camera can operate as a backup recording device for the surveillance system if network communication is lost due to a network failure.

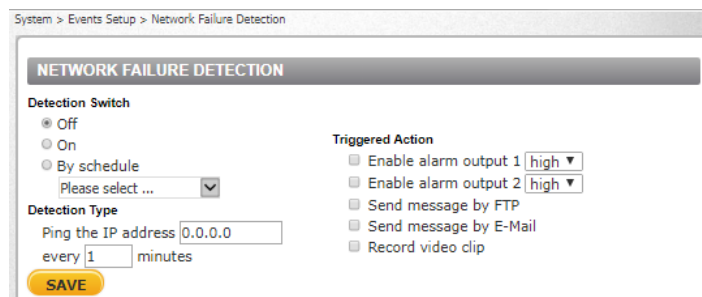

Network Failure Detection Screen

Detection Switch

The Administrator can select from the following options:

- Select *Off* to disable an alarm (default setting).
- Select *On* to enable an alarm.
- Select *By Schedule* to set a schedule. Then click *Please Select* to select up to 10 schedules from the drop-down list that opens. The selected schedules are displayed in the *Please Select* text box. To set a schedule, open the [Schedule](#) tab.

Click **SAVE** after configuring the settings.

Detection Type

In the text box, enter the IP address to ping and the time interval (in minutes) between pings. Click **SAVE** after configuring the settings.

Triggered Action

The Administrator can specify various alarm actions to take when an alarm is triggered. See the [Triggered Actions](#) section for a detailed description of the actions. The following options are available:

- *Enable alarm output 1*– Check this box and select the predefined type of alarm output (*low* or *high*) to enable alarm relay when a network failure is detected.
- *Enable alarm output 2*– Check this box and select the predefined type of alarm output (*low* or *high*) to enable alarm relay when a network failure is detected.
- *Send message by FTP* – Select whether to send an alarm message by FTP when a network failure is detected.
- *Send message by E-Mail* – Select whether to send an alarm message by e-mail when a network failure is detected.
- *Record video clip* – Select this box in order to save the alarm-triggered recording to the local SD / microSDXC card.

Click **SAVE** to save the network failure detection settings.

5.4.4.3 Tampering

The **Tampering** screen is used to configure settings for tamper detection alarms. Tampering alarm is defined by a minimum duration of a tampering action and a sensitivity level. When triggered, the tampering event can perform several actions in response.

Note: Tampering is only effective when the camera is stationary.

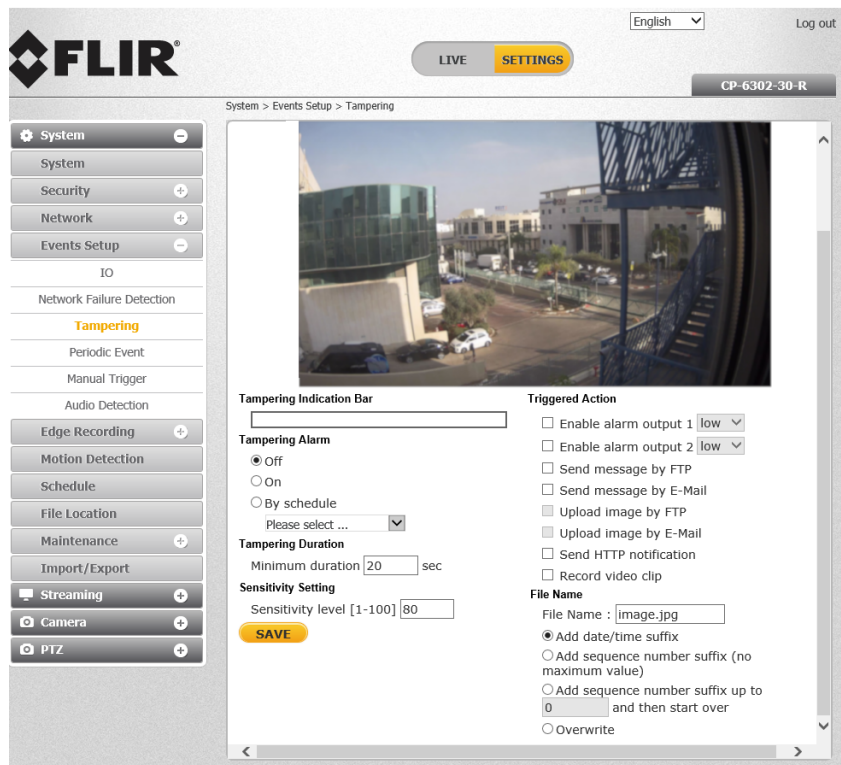

Tampering Screen

Tampering Indication Bar

The Tampering Indication bar gives the user a visual display of the threshold for how much Tampering is accruing. This indication bar will be effected by the sensitivity settings mentioned below.

Tampering Alarm

Four alarms are available. For each alarm, the Administrator can select from the following options:

- Select *Off* to disable an alarm.
- Select *On* to enable an alarm (default setting).
- Select *By Schedule* to set a schedule. Then click *Please Select* to select up to 10 schedules from the drop-down list that opens. The selected schedules are displayed in the *Please Select* text box. To set a schedule, open the [Schedule](#) tab.

Click **SAVE** after configuring the settings.

Tampering Duration

The minimum duration set for tampering indicates the amount of time tampering must take place before the camera considers it a tampering event.

Sensitivity Setting

Setting the sensitivity [1-100] determines the amount of tampering that will trigger an event (i.e. how much movement of the camera).

Triggered Action

The Administrator can specify various alarm actions to take when an alarm is triggered. See the [Triggered Actions](#) section for a detailed description of the actions. The following options are available:

- *Enable alarm output 1* – Check this box and select the predefined type of alarm output (*low* or *high*) to enable alarm relay when a network failure is detected.
- *Enable alarm output 2* – Check this box and select the predefined type of alarm output (*low* or *high*) to enable alarm relay when a network failure is detected.
- *Send Message by FTP* – The Administrator can select whether to send an alarm message by FTP when an alarm is triggered.
- *Send message by E-Mail* – The Administrator can select whether to send an alarm message by e-mail when an alarm is triggered.
- *Upload Image by FTP* – Selecting this option enables you to assign an FTP site and configure various parameters.
- *Upload image by E-Mail* – Select this checkbox to assign an e-mail address for sending the image captured by a triggered alarm. The e-mail address is entered in the [Mail](#) screen.
- *Send HTTP notification* – Select this checkbox to send a notification by HTTP.
- *Record video clip* – Select this box in order to save the alarm-triggered recording to the local SD / microSDXC card or to the NAS.

Click **SAVE** after configuring the settings.

File Name

- *File Name* – Enter a file name in the field, for example *image.jpg*. The uploaded image's file name format is set in this section. Select one that meets your requirements.
- Add date/time suffix (default setting)
File name: imageYMMDD_HHNNSS_XX.jpg
Y: Year, M: Month, D: Day
H: Hour, N: Minute, S: Second
X: Sequence Number
- Add sequence number suffix (no maximum value)
File name: imageXXXXXXXX.jpg
X: Sequence Number
- Add sequence number suffix (limited value)
File Name: imageXX.jpg
X: Sequence Number

The file name suffix ends at the number being set. For example, if the setting is up to "10," the file name will start from 00, end at 10, and then start over again.

- Overwrite
The original image in the FTP site will be overwritten by the new uploaded file with a static filename.

Click **SAVE** after configuring the settings.

5.4.4.4 Periodic Event

The **Periodic Event** screen is used to specify an alarm to be triggered at a specified time interval.

Periodic Event Screen

Periodic Event

Select *Off* or *On* to activate this function. The default is *Off*.

Time Interval

In the *Minimum interval* text box, enter the number of seconds for the minimum interval between alarms. The range is from 20 to 3600 seconds. The default is 60.

Triggered Action

The Administrator can specify various alarm actions to take when an alarm is triggered. See the [Triggered Actions](#) section for a detailed description of the actions. The following options are available:

- *Upload Image by FTP* – Selecting this option enables you to assign an FTP site and configure various parameters.
- *Upload Image by E-Mail* – Selecting this option enables you to assign an e-mail address and configure various parameters.

Click **SAVE** to save the network failure detection settings.

File Name

- *File Name* – Enter a file name in the field, for example *image.jpg*. The uploaded image's file name format is set in this section. Select one that meets your requirements.
- Add date/time suffix (default setting)
File name: imageYYMMDD_HHNNSS_XX.jpg
Y: Year, M: Month, D: Day
H: Hour, N: Minute, S: Second
X: Sequence Number
- Add sequence number suffix (no maximum value)
File name: imageXXXXXXXX.jpg
X: Sequence Number
- Add sequence number suffix (limited value)
File Name: imageXX.jpg
X: Sequence Number

The file name suffix ends at the number being set. For example, if the setting is up to “10,” the file name will start from 00, end at 10, and then start over again.

- Overwrite
The original image in the FTP site will be overwritten by the new uploaded file with a static filename.

Click **SAVE** after configuring the settings.

5.4.4.5 Manual Trigger

The **Manual Trigger** screen is used to specify an alarm to be manually triggered. You can define action to take when an alarm occurs from the [System > Events Setup > IO](#) screen.

Manual Trigger Screen

Manual Trigger

Select *Off* or *On* to activate this function. The default is *Off*.

Triggered Action

The Administrator can specify various alarm actions to take when an alarm is triggered. See the [Triggered Actions](#) section for a detailed description of the actions. The following options are available:

- *Enable alarm output 1* – Check this box and select the predefined type of alarm output (*low* or *high*) to enable alarm relay when a network failure is detected.
- *Enable alarm output 2* – Check this box and select the predefined type of alarm output (*low* or *high*) to enable alarm relay when a network failure is detected.
- *Send Message by FTP* – The Administrator can select whether to send an alarm message by FTP when an alarm is triggered.
- *Send message by E-Mail* – The Administrator can select whether to send an alarm message by e-mail when an alarm is triggered.
- *Upload Image by FTP* – Selecting this option enables you to assign an FTP site and configure various parameters.
- *Upload image by E-Mail* – Select this checkbox to assign an e-mail address for sending the image captured by a triggered alarm. The e-mail address is entered in the [Mail](#) screen.
- *Send HTTP notification* – Select this checkbox to send a notification by HTTP.
- *Record video clip* – Select this box in order to save the alarm-triggered recording to the local SD / microSDXC card or to the NAS.
- *PTZ Function* – Select this checkbox to set a Preset, Sequence, Auto Pan, or Pattern; Function line; or Dwell time. These functions can be configured in more detail from the [Settings > PTZ](#) tab.

Click **SAVE** after configuring the settings.

File Name

- **File Name** – Enter a file name in the field, for example *image.jpg*. The uploaded image's file name format is set in this section. Select one that meets your requirements.
- Add date/time suffix (default setting)
File name: imageYYMMDD_HHNNSS_XX.jpg
Y: Year, M: Month, D: Day
H: Hour, N: Minute, S: Second
X: Sequence Number
- Add sequence number suffix (no maximum value)
File name: imageXXXXXXXX.jpg
X: Sequence Number
- Add sequence number suffix (limited value)
File Name: imageXX.jpg
X: Sequence Number

The file name suffix ends at the number being set. For example, if the setting is up to “10,” the file name will start from 00, end at 10, and then start over again.

- **Overwrite**
The original image in the FTP site will be overwritten by the new uploaded file with a static filename.

Click **SAVE** after configuring the settings.

5.4.4.6 Audio Detection

The **Audio Detection** screen is used for setting the audio threshold level of the audio input. An audio event is created when the threshold is exceeded. Actions include:

- Sending two alarms
- Sending to an FTP server
- Sending a message by email
- Uploading a snapshot by FTP
- Uploading a snapshot by email
- Sending a notification by HTTP
- Recording a video clip of an event on the camera's SD / microSDXC card

System > Events Setup > Audio Detection

AUDIO DETECTION

<p>Audio Detection</p> <p><input checked="" type="radio"/> Off <input type="radio"/> On</p> <p>Audio Detection Setting</p> <p>Detection Level [1-100] <input style="width: 40px;" type="text" value="10"/> Time interval (sec) [0-7200] <input style="width: 40px;" type="text" value="10"/></p> <p style="text-align: center;">SAVE</p>	<p>Triggered Action</p> <p><input type="checkbox"/> Enable alarm output 1 <input style="width: 40px;" type="text" value="high"/> <input type="checkbox"/> Enable alarm output 2 <input style="width: 40px;" type="text" value="high"/> <input type="checkbox"/> Send message by FTP <input type="checkbox"/> Send message by E-Mail <input type="checkbox"/> Upload image by FTP <input type="checkbox"/> Upload image by E-Mail <input type="checkbox"/> Send HTTP notification <input type="checkbox"/> Record video clip</p> <p>File Name</p> <p>File Name : <input style="width: 80px;" type="text" value="image.jpg"/> <input checked="" type="radio"/> Add date/time suffix <input type="radio"/> Add sequence number suffix (no maximum value) <input type="radio"/> Add sequence number suffix up to <input style="width: 40px;" type="text" value="0"/> and then start over <input type="radio"/> Overwrite</p>
---	--

Audio Detection Screen

Detection Switch

The Administrator can select from the following options:

- Select *Off* to disable audio (default setting).
- Select *On* to enable audio.
- Select *By Schedule* to set a schedule. Then click *Please Select* to select up to 10 schedules from the drop-down list that opens. The selected schedules are displayed in the *Please Select* text box. To set a schedule, open the [Schedule](#) tab.

Click **SAVE** after configuring the settings.

Audio Detection Setting

Set the Detection Level and Time Interval for detecting audio.

- Set Detection Level – Setting a low threshold (for example, 25) means that the camera is more sensitive to noise, which results in more alerts (displayed in red). The setting depends on the situation and environment. If the scene is located in a quiet place, it is possible to use lower threshold. A noisy location requires a higher threshold.

Triggered Action

The Administrator can specify various alarm actions to take when an alarm is triggered. See the [Triggered Actions](#) section for a detailed description of the actions. The following options are available:

- *Enable alarm output 1* – Check this box and select the predefined type of alarm output (*low* or *high*) to enable alarm relay when a network failure is detected.
- *Enable alarm output 2* – Check this box and select the predefined type of alarm output (*low* or *high*) to enable alarm relay when a network failure is detected.
- *Send message by FTP* – Select whether to send an alarm message by FTP when a network failure is detected.
- *Send message by E-Mail* – Select whether to send an alarm message by e-mail when an audio event is detected.
- *Upload Image by FTP* – Selecting this option enables you to assign an FTP site and configure various parameters.
- *Upload image by E-Mail* – Select this box in order to assign an e-mail address and configure various parameters.
- *Send HTTP notification* – Select this checkbox to send a notification by HTTP.
- *Record video clip* – Select this box in order to save the alarm-triggered recording to the local SD / microSDXC card or to the NAS.

Click **SAVE** after configuring the settings.

File Name

- *File Name* – Enter a file name in the field, for example *image.jpg*. The uploaded image's file name format is set in this section. Select one that meets your requirements.
- Add date/time suffix (default setting)
File name: imageYYMMDD_HHNNSS_XX.jpg
Y: Year, M: Month, D: Day
H: Hour, N: Minute, S: Second
X: Sequence Number

- Add sequence number suffix (no maximum value)
File name: imageXXXXXXXX.jpg
X: Sequence Number
- Add sequence number suffix (limited value)
File Name: imageXX.jpg
X: Sequence Number

The file name suffix ends at the number being set. For example, if the setting is up to “10,” the file name will start from 00, end at 10, and then start over again.

- Overwrite
The original image in the FTP site will be overwritten by the new uploaded file with a static filename.

Click **SAVE** after configuring the settings.

5.4.4.7 Triggered Actions

Triggered Action

The Administrator can specify various alarm actions to take when an alarm is triggered. The following options are available:

- *Enable alarm output 1* – Check this box and select the predefined type of alarm output (*low* or *high*) to enable alarm relay when a network failure is detected. The default setting is *low*.
- *Enable alarm output 2* – Check this box and select the predefined type of alarm output (*low* or *high*) to enable alarm relay when a network failure is detected. The default setting is *low*.
- *Send Message by FTP* – The Administrator can select whether to send an alarm message by FTP when an alarm is triggered.
- *Send message by E-Mail* – The Administrator can select whether to send an alarm message by e-mail when an alarm is triggered.



Note:

Images can be sent by email only when *MJPEG* is selected as the video stream from the [Video Configuration](#) screen.

Select one of two e-mail addresses from the drop-down menu. Select the number of frames for the pre-trigger and post-trigger buffers from the drop-down menu of 1-20 frames.

Check the box for *Continuous image upload* if you wish to use this option. To specify the length of time for the upload, click this radial button and enter the number of seconds. To upload while the trigger is active, click this radial button. Finally, select the number of frames per second from the drop-down menu next to *Image frequency*.



Note:

Make sure SMTP or FTP configuration has been completed. See the [Mail](#) and [FTP](#) sections for further details.

- *Upload Image by FTP* – Selecting this option enables you to assign an FTP site and configure various parameters. When an alarm is triggered, event images will be uploaded to the designated FTP site.

Upload image by FTP

FTP address

Pre-trigger buffer

Post-trigger buffer

Continuous image upload

Upload for sec

Upload while the trigger is active

Image frequency fps

Upload Image by FTP Settings



Note:

Images can be sent by FTP only when *MJPEG* is selected as the video stream from the [Video Configuration](#) screen.

Specify the FTP address to use from the drop-down menu. Select the number of frames for the pre-trigger and post-trigger buffers from the drop-down menu of 1-20 frames.

Check the box for *Continuous image upload* if you wish to use this option. To specify the length of time for the upload, click this radial button and enter the number of seconds. To upload while the trigger is active, click this radial button.

Finally, select the number of frames per second from the drop-down menu next to *Image frequency*.

- *Upload image by E-Mail* – Select this checkbox to assign an e-mail address for sending the image captured by a triggered alarm. The e-mail address is entered in the [Mail](#) screen.



Note:

Images can be sent by e-mail only when *MJPEG* is selected as the video stream from the [Video Configuration](#) screen.

- From the *E-Mail address* drop-down list, select one of the two e-mail addresses.
- From the *Pre-trigger buffer* and *Post-trigger buffer* drop-down lists, select the number of frames for the buffer from 1-20 frames.

Upload image by E-Mail

E-Mail address

Pre-trigger buffer

Post-trigger buffer

Continuous image upload

Upload for sec

Upload while the trigger is active

Image frequency fps

Upload Image by E-Mail Settings

- Check the *Continuous image upload* box if you wish to upload an image by e-mail for a defined period of time or while the trigger is active. Select one of the following options:
 - To specify the length of time for the upload, select *Upload for* and enter the number of seconds in the text box.
 - To upload while the trigger is active, select *Upload while the trigger is active*.

In the *Image Frequency* text box, from the drop-down list select the number of frames per seconds from 1-15 for the upload.



Note:
Make sure that SMTP configuration has been completed. See [Mail](#) for details.

- *Send HTTP notification* – Select this checkbox to send a notification by HTTP. Select the destination HTTP address from the drop-down menu and specify the parameters for event notifications by the IO event triggered. When an alarm is triggered, the notification will be sent to one of two specified HTTP servers. See figure below.

Send HTTP notification

HTTP address

Custom parameters

Send HTTP Notification Settings

- *Record video clip* – Select this box in order to save the alarm-triggered recording to your microSDXC card or to the NAS. Enter the number of seconds for the pre-trigger buffer. Select the first radial button if you wish to upload for a specified length of time and enter the number of seconds. Alternatively, select the second radial button to upload while the trigger is active.

Record video clip

Record to

Pre-trigger buffer sec

Upload for sec

Upload while the trigger is active

Record Video Clip Settings



Note:
In order to use this function, make sure that local recording with a microSDXC card is activated and that the NAS is properly configured. See [Recording](#) for further details.

- *PTZ Function* – Select this checkbox to set a Preset, Sequence, Auto Pan, or Pattern; Function line; or Dwell time. These functions can be configured in more detail from the [Settings > PTZ](#) tab.

PTZ Function

Preset

Function line:

Dwell time:

PTZ Function Settings

Click **SAVE** after configuring the settings.

5.4.5 Edge Recording

The **Events Recording** tab is used for configuring settings for the various methods used for event notification. The tab includes the following screens:

[SD Card](#) [Network Share](#) [Recording](#)

5.4.5.1 SD Card

You can locally record up to 1TB on a Class 10 SD / microSDXC card. The **SD Card** page shows the capacity information of the memory card and a recording list of all the recording files saved on the card. You can also format the card and implement automatic recording cleanup on this page. To implement SD / microSDXC card recording, see [Recording](#).

SD Card Screen



Note:

Format the SD / microSDXC card when using it for the first time. Formatting is also required when a memory card has been used on one camera and is then transferred to a camera that uses a different software platform.

Device Information

Upon inserting the SD / microSDXC card, card information, such as the memory capacity and status, is displayed.

Device Setting

Select *vfat* (default) or *ext4* (recommended). Click **FORMAT** to format the memory card.

Disk Cleanup Setting

Enable automatic recording cleanup by selecting *Enable automatic disk cleanup*. From the pull-down menu, specify the minimum length of time over which to remove recordings. For example, remove recordings over 10 days old. Enter the percent of disk capacity used in order to remove the oldest recordings. Click **SAVE** when finished.

Recording List

Each video file on the SD / microSDXC card is listed in the Recording List table below. The maximum file size is 60 MB per file. See [Recording](#) for further details.

When the recording mode in the **Recording** screen is set as *Always* (consecutive recording) and the SD / microSDXC card recording is enabled by events triggered, the system immediately saves a recorded event on the memory card once an event occurs. The camera then returns to the regular recording mode after events recording.



Video Clip Recording List

- **Remove** – To remove a file, first select the file and then click **REMOVE**.
- **Sort** – Click **SORT** to list the files in the Recording List table in order of name and date.



Note:

The capital letters: R, N, A, (A0), M, (M0) followed by an underscore, appear at the beginning of the file name. They denote the type of recording.

- R - Regular (always or schedule)
 - N - Network failure
 - M - Motion, (M0 refers to the first motion window trigger)
 - A - Alarm (A0 refers to the first alarm trigger input).
- **Download** – To open/download a video clip, first select the file and then click **DOWNLOAD**. The selected file window pops up as shown below. Click the AVI file to play the video in the player or download it to a specified location.

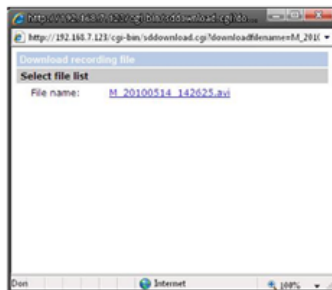

Selected File Window

5.4.5.2 Network Share

The **Network Share** screen shows the capacity information of the Network Attached Storage (NAS) disk and provides a list of all the recording files saved on the disk.

Network Share Screen

You can also format the disk and implement automatic recording cleanup on this page. To implement NAS recording, see [Recording](#).

Device Information

Upon connecting to the NAS, the following information about the disk is displayed:

- *Device type* – Displays *Network Share*
- *Free space* – Displays the amount of available storage space in GB
- *Total size* – Displays the total amount of storage space in GB
- *Status* – Indicates if the camera is online or offline
- *Full* – Indicates if the disk is full (Yes/No)
- *Protocol* – Displays the protocol used by the NAS. The default is SAMBA.

Enter the details for the following fields:

- *Host* – Enter the host IP address
- *Share* – Enter the path for a shared network storage device
- *User name* – Enter the name of the user accessing the NAS
- *Password* – Enter the password of the user accessing the NAS

When the camera is in its default state, the hidden characters that appear in the password field are empty. Type in the password.

Storage Tools

Click **FORMAT** to format the NAS.

Disk Cleanup Setting

Enable automatic recording cleanup by selecting *Enable automatic disk cleanup*. From the pull-down menu, specify the minimum length of time over which to remove recordings. For example, remove recordings over 10 days old. Enter the percent of disk capacity used in order to remove the oldest recordings. Click **SAVE** when finished.

Recording List

Each video file stored on the NAS is listed in the Recording list. See [Recording](#) for further details. When the recording mode in the **Recording** screen is set as *Always* (consecutive recording) and the NAS recording is enabled by events triggered, the system immediately saves a recorded event on the network disk once an event occurs. Then the camera will return to the regular recording mode after events recording. See Figure: [Selected File Window](#).

- *Remove* – To remove a file, first select the file and then click **REMOVE**.
- *Sort* – Click **SORT** to list the files in the Recording list in order of name and date.



Note:

The capital letters: R, N, A, (A0), M, (M0) followed by an underscore, appear at the beginning of the file name. They denote the type of recording.

- R - Regular (always or schedule)
 - N - Network failure
 - M - Motion, (M0 refers to the first motion window trigger)
 - A - Alarm (A0 refers to the first alarm trigger input).
- *Download* – To open/download a video clip, first select the file and then click **DOWNLOAD**. The selected file window pops up as shown below. Click the AVI file to play the video in the player or download it to a specified location. See Figure: [Selected File Window](#).

5.4.5.3 Recording

The **Recording** screen is used to select a device and to set a schedule for recording clips. Up to 10 schedules can be set.

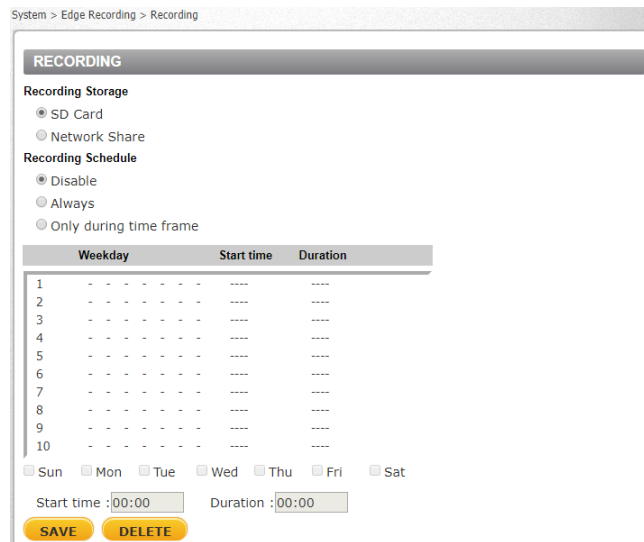

Recording Screen

In the *Recording Storage* section, select the recording device: *SD Card* or *Network Share*.



Note:

It is not recommend to record with the local SD / microSDXC card for 24/7 continuously, as it may not be able to support long term continuous data read/write. Contact the manufacturer of the SD / microSDXC card for information regarding its reliability and life expectancy.

In the *Recording Schedule* section, specify the recording schedule. Select one of three options:

- *Disable* – Disable this function
- *Always* – Always use this function
- *Only during time frame* – Records only during a specified time frame

To set the recording schedule

1. Select the day.
2. Set the start time.
3. Set the duration for recording.
4. Click **SAVE** to confirm the schedule. The schedule is displayed in the table.



Note:

This option works only if (a) the SD / microSDXC card is installed in the camera or (b) the NAS is configured properly.

5.4.6 Motion Detection

The motion detection function detects suspicious motion and triggers alarms when motion volume in the detected region reaches or exceeds the determined sensitivity threshold value. The Live View pane on the **Motion Detection** screen is used for creating motion detection regions and indicating motion detection. It is possible to define up to four motion detection regions within the Live View pane. The motion detection function is disabled by default.

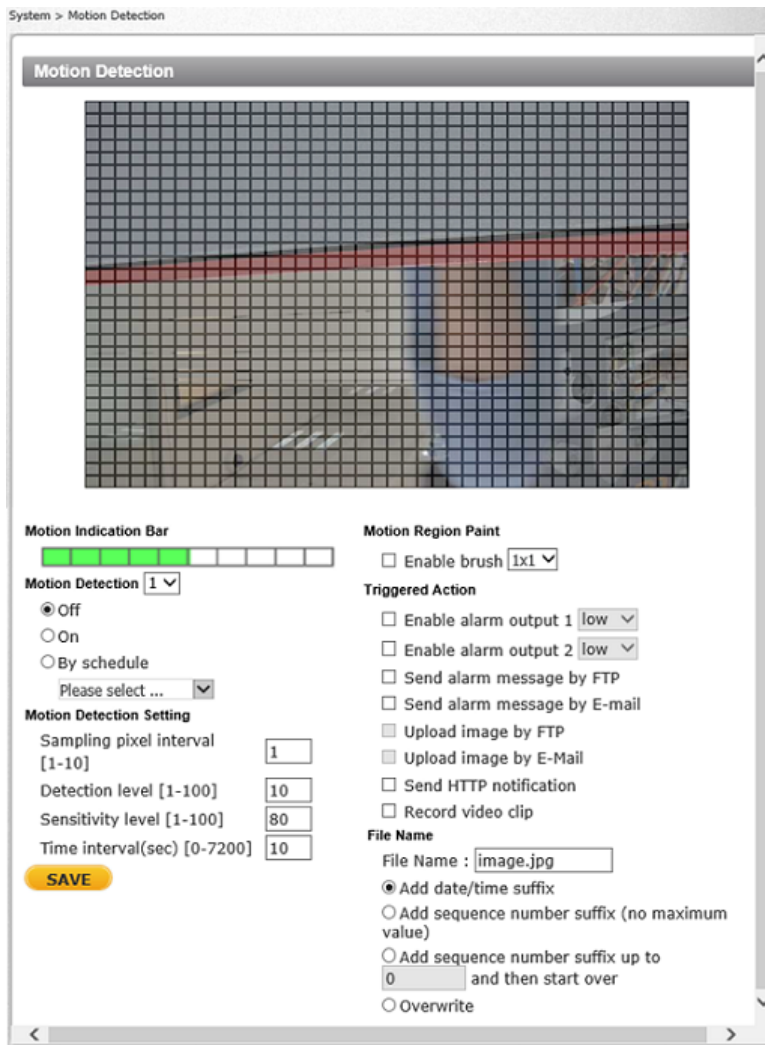

Motion Detection Screen

Detected motion is displayed in the Motion Indication Bar. After motion detection has been activated, the bar is divided into 10 segments; each one representing a sensitivity level. Once the motion exceeds the set sensitivity level, the bar turns from green to red.



Note:

If you are using Latitude, it is recommended to set the motion detection from Admin Center.

To activate Motion Detection

1. From the *Motion Detection* drop-down list, select a number from 1 to 4.
2. Do one of the following for each detection region:
 - Select *On* for continuous detection.
 - Select *By schedule* for scheduled detection. For instructions how to set a schedule for motion detection, refer to [Schedule](#).
3. To create a Motion Detection region, select *Enable Paintbrush*.
4. From the *Enable Paintbrush* drop-down menu, select the size of the region (*1x1*, *3x3*, or *5x5*).
5. To clear the region, right-click your mouse and scroll over the region.
6. Configure the motion detection settings. See instructions below.
7. Set triggered actions. See instructions below.

To set a schedule

1. Select *By schedule*. The message “Please Select” is displayed.
2. Click *Please select*. A drop-down menu opens.
3. From the drop-down menu, select a schedule from 1 to 10. The selected schedules are displayed in a horizontal field above the drop-down menu.
4. Click **SAVE**.

To configure motion detection settings

1. *Sampling pixel interval [1-10]* – Select a number from 1-10. The default value is 1. If the value is set as 3, within the detection region, the system will take one sampling pixel for every 3 pixels by each row and each column (see the figure below).

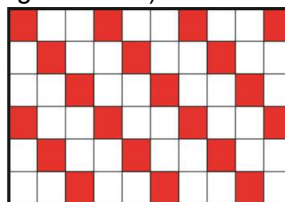

Pixel Interval Illustration

2. *Detection level [1-100]* – Select a number from 1-100. The default level is 40. This sets detection level for each sampling pixel; the smaller the value, the more sensitive it is.
3. *Sensitivity level [1-100]* – Select a number from 1-100. The default level is 60, which means if 40% or more sampling pixels are detected differently, the system will detect motion. The bigger the value, the more sensitive it is and more colored segments will be displayed in the Motion Indication Bar.
4. *Time interval (sec) [0-7200]* – Select a number from 0-7200 (seconds). The default interval is 10. The value is the interval between each detected motion.

Triggered Action

The Administrator can specify various alarm actions to take when an alarm is triggered. See the [IO](#) section for a detailed description of the actions. The following options are available:

- *Enable alarm output 1* – Check this box and select the predefined type of alarm output (*low* or *high*) to enable alarm relay when motion is detected.
- *Enable alarm output 2* – Check this box and select the predefined type of alarm output (*low* or *high*) to enable alarm relay when motion is detected.
- *Send alarm message by FTP* – Select whether to send an alarm message by FTP when motion is detected.
- *Send alarm message by E-Mail* – Select whether to send an alarm message by e-mail when motion is detected.
- *Upload image by FTP* – Select this box in order to upload an image to a designated FTP site when motion is detected according to various parameters.
- *Upload image by E-Mail* – Select this box in order to assign an e-mail address and configure various parameters.
- *Send HTTP notification* – Check this box to send a notification by HTTP.
- *Record video clip* – Select this box in order to save the alarm-triggered recording to the local SD / microSDXC card or to the NAS.

File Name

The uploaded image's filename format is set in this section. Select one that meets your requirements. Click **SAVE** to save the motion detection settings.

5.4.7 Schedule

The **Schedule** screen is used for setting schedules for the network failure detection and motion detection functions. The functions in this tab allow administrators to create customized schedules for the camera that uses this option. If a schedule exists, the administrator can apply that schedule to this camera using the available drop-down list. See figure below.

System > Schedule

SCHEDULE

Weekday	Start time	Duration
2	----	----
3	----	----
4	----	----
5	----	----
6	----	----
7	----	----
8	----	----
9	----	----
10	----	----

Sun
 Mon
 Tue
 Wed
 Thu
 Fri
 Sat

Day
 Night
 Time
 Start time :
 Duration :

Schedule Screen

To access the schedule function, open the **Main** window, select the **System** tab, and click the **Schedule** tab.

**Note:**

This application is not the same as the Recording Schedule function. It is not used for recording live video.

To create a new schedule or edit an existing schedule

1. Select the appropriate checkbox for the day(s) of the week (Sun, Mon, Tue, Wed, Thu, Fri and Sat) to create a schedule.
2. Set *Start time* (for example, 09:00) and *Duration* (for example, 4:00 hours).
3. Click **Save** to apply the newly created schedule to the camera.

To remove a schedule

1. To remove a schedule, select the setup data line by line.
2. Click **Delete** to remove.

5.4.8 File Location

From the **File Location** page, specify a storage location for snapshots and web recordings. The default setting is: C:\. After confirming the setting, click **SAVE** to save the snapshots and recordings in the designated location.

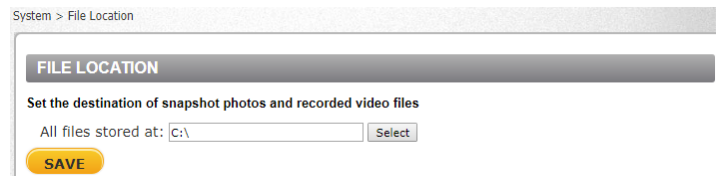

File Location Screen

**Note:**

1. Make sure the selected file path contains valid characters.
2. When using Windows 8 OS, the storage location cannot be C:\. You must define a storage location that does not require Administrator privileges on the PC.

5.4.9 Maintenance

Clicking the **Maintenance** tab in the **System** screen opens a drop-down menu with the following tabs:

[Log File](#) [User Information](#) [Factory Default](#) [Software Version](#) [Software Upgrade](#) [Parameters](#)

5.4.9.1 Log File

Click **Log file** to view the system log file. The content of the file provides information about connections after system boot-up.

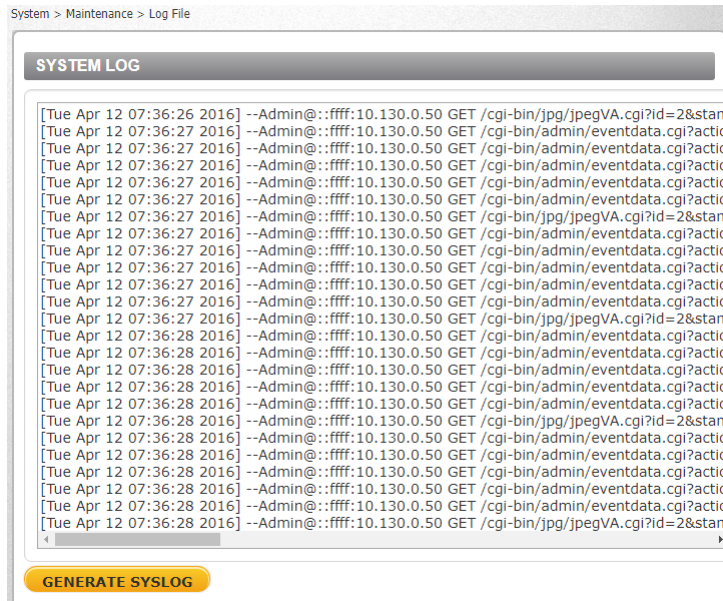

System Log Screen

5.4.9.2 User Information

The Administrator can view each user's login information and privileges in the **User information** screen shown below.

View User Login Information

Click **GET USER INFORMATION** to see each user's details. For example: *Admin: 1234*. This indicates that the user's login username is *Admin* and the password is *1234*.

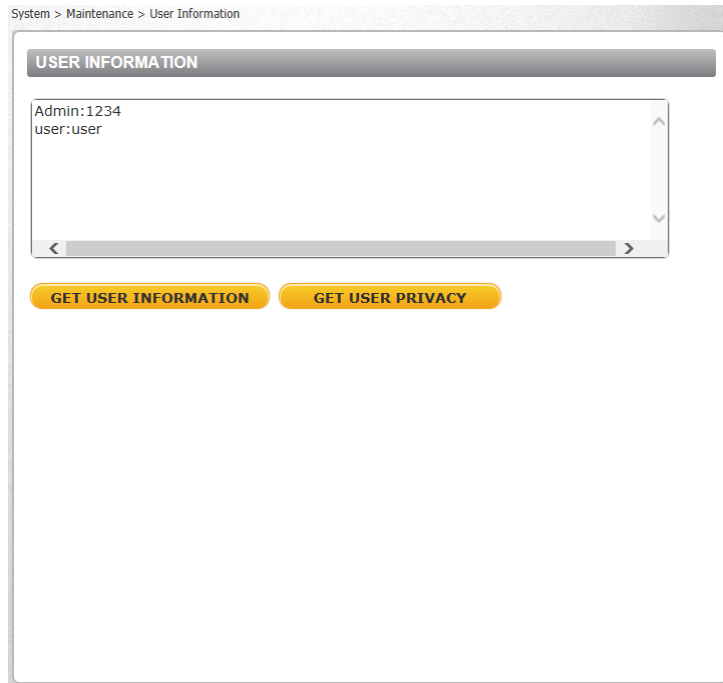

User Information Screen – Get User Information

View User Privileges

Click **GET USER PRIVACY** to view each user's privileges.

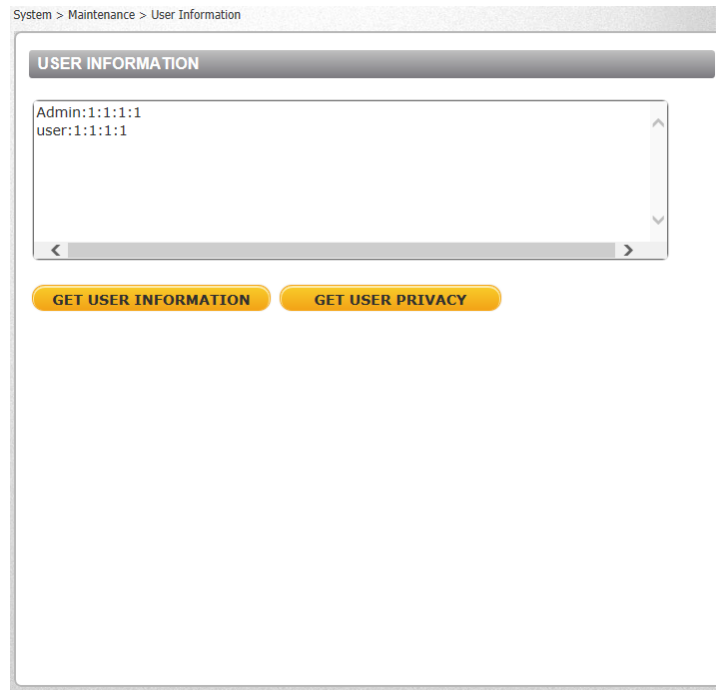

User Information – Get User Privacy

In the screen above, both *Admin* and *User* are granted privileges of I/O access, Camera control, Talk and Listen, which are the maximum privileges that can be granted.



Note:

User credentials and privileges are set in the [User](#) screen.

5.4.9.3 Factory Default

The **Factory Default** page is shown below. Follow the instructions to reset the camera to factory default settings if needed.

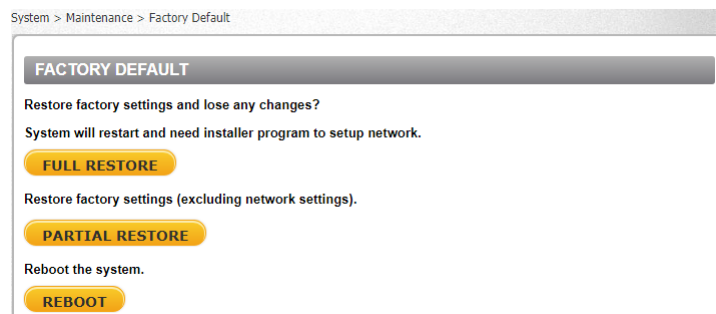

Factory Default Screen

Full Restore

Click **FULL RESTORE** to restore the factory default settings. The system restarts in 30 seconds.



Note:

The IP address and all other settings will be restored to factory default settings.

Partial Restore

Click **PARTIAL RESTORE** to restore the factory default settings, but save the network settings. The system restarts in 30 seconds.



Partial Restore Screen

Reboot

Click **REBOOT** to restart the system without changing current settings.

5.4.9.4 Software Version

The current version of the software is displayed in the **Software Version** screen.



Software Version Screen

5.4.9.5 Software Upgrade

The **Software Upgrade** screen enables you to select a software file to upload.

Software Upgrade Screen



Note:

1. Make sure that the software upgrade file is available before performing a software upgrade.
2. Do not change the file name. If you change the upgrade file name, the system will fail to find the file.
3. Software can also be upgraded via DNA version 2.1.3.15 or higher.



Caution:

1. Do not unplug power while entering file names.
2. Do not unplug power or change the screen while upgrading software.

Attention:

1. *Ne débranchez pas l'alimentation pendant la modification des noms de fichiers.*
2. *Ne débranchez pas l'alimentation pendant la mise à niveau du logiciel.*

To upgrade the software

1. In the *Step 1* text box, click **Browse** and select the binary file to be uploaded, for example, `uImage+userland.img`.



Note:

Do not change the file name. If you change the upgrade file name, the system will fail to find the file.

2. From the drop-down menu of binary files in *Step 2*, select the file to upgrade. In the above example `uImage+userland.img` is selected.

3. Click **UPGRADE**. The system verifies that the upgrade file exists and begins to upload the file. The upgrade status bar is displayed on the page. When the upgrade process is completed, the **Live** page is displayed.
4. Close the web browser.
5. From the Windows Start menu, select *Control Panel*.
6. Select *Uninstall a Program* to delete the existing DVPlayer or DCViewer plug-in file.



Note:

An installed program should be deleted and a new Quasar Player should be installed only when prompted by the user interface.

7. In the *Currently installed programs* list, select *Quasar Player*.
8. Click **Uninstall** to delete the existing plug-in file.



Note:

For more information about deleting an existing web player, see [Installing and Deleting the Web Player](#).

9. Install the new ActiveX plug-in.

5.4.9.6 Parameters

The **Parameters** screen displays all of the system's parameter settings.

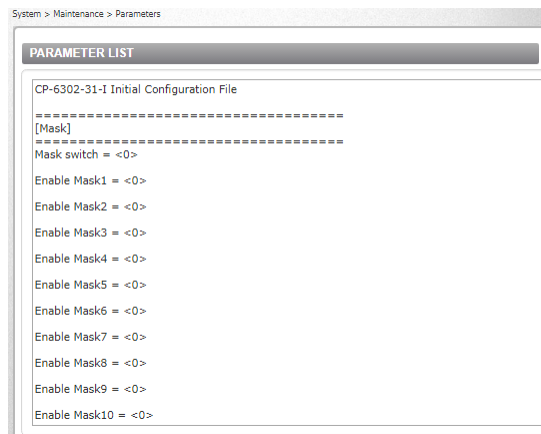

Parameters Screen



Note:

Slide the sidebar located on the right of the screen to view the entire list of parameters.

5.5 Import/Export

From the **Import/Export** screen you can export configuration files to a specified location and retrieve data by uploading an existing configuration file to the camera.

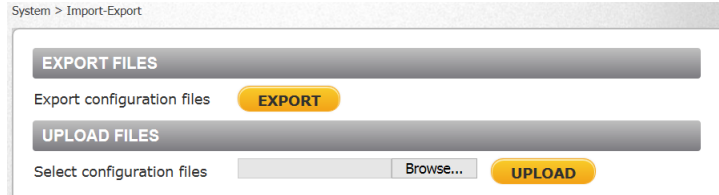

Import/Export Screen

To export a configuration file

1. Click **EXPORT**. An information bar opens.

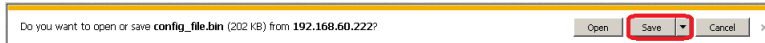

File Download Screen

2. Click **Save**.
3. Specify a location to save the configuration file.

To import a configuration file

1. Click **Browse** to select the configuration file
2. Click **UPLOAD**. The file is uploaded to the camera.



Note:

Do not change the file name. If you change the upgrade file name, the system will fail to find the file.



Caution:

Do not unplug power while changing file names.

Attention:

Ne débranchez pas l'alimentation pendant la modification des noms de fichiers.

5.6 Streaming Tab

Select the **Streaming** tab in the navigation bar at the top of the page to display the configurable video and audio selections in the sidebar. From the **Streaming** sidebar, the Administrator can configure a specific video resolution, video compression mode, video protocol, video frame rate, and audio transmission mode.

Details of these settings are specified in the following sections:

[Video Configuration](#) [Video Rotation](#) [Video Text Overlay](#) [Video OCX Protocol](#) [Audio](#)

5.6.1 Video Configuration

The **Video Configuration** screen is used for configuring most video settings.

The selected *Encode Type* (video compression) determines what settings are available. If you use Google Chrome, Mozilla Firefox, or Microsoft Edge to access the camera's browser-based user interface, you must select *MJPEG* for at least one of the video streams. By default, Stream 1 and Stream 2 are enabled at 1920 x 1080 fps.

The screenshot shows the 'VIDEO CONFIGURATION' screen with the following settings for each stream:

Stream	Encoding	Encode Type	Profile	Resolution	Frame Rate	Rate Control	Bit Rate	GOV Length	Dynamic GOV	Q Factor
Stream 1	Yes	H.265	Main profile	1920 x 1080	30	CBR	725	84		
Stream 2	Yes	H.265	Main profile	1920 x 1080	30	VBR	899	45		
Stream 3	Yes	H.264	Main profile	1920 x 1080	30	LBR	725	84	Disabled	
Stream 4	Yes	MJPEG		1920 x 1080	9					35

Buttons: SAVE, RESET

Video Configuration Screen

5.6.1.1 Video Resolutions

The following streams are supported:

- [Single-Stream H.265](#)
- [Single-Stream H.264](#)
- [Single-Stream MJPEG](#)
- [Dual-Stream](#)
- [Triple-Stream](#)
- [Quad-Stream](#)



Note:

1. The performance on Streams 2, 3, and 4 depends on the combination and settings of each stream configured before it. For example, Stream 4 performance depends on the settings for Streams 1, 2, and 3. Stream 3 performance depends on the settings for Streams 1 and 2.
2. The maximum frame rate on Streams 2, 3, and 4 also depends on the selection of *WDR 2 Shutter (PAL)* or *WDR 2 Shutter (NTSC)* for maximum 25/30 frames per second, or *50 fps (PAL)* or *60 fps (NTSC)* for maximum 50/60 frames per second from the [Camera > Misc.](#) screen.
3. Images can be sent by FTP or email only when MJPEG steaming is selected as one of the streams.
4. United VMS supports only three streams.

5.6.1.1.1 Single-Stream H.265

To implement single-stream H.265 compression

1. In the Stream 1 section, from the *Encode Type* drop-down menu, select *H.265*. The section expands. The following options are available if you select *CBR Rate Control*:

H.264/H.265 with CBR Rate Control

The following options are available if you select *VBR Rate Control*:

H.264/H.265 with VBR Rate Control

The following options are available if you select *LBR Rate Control* and disable *Dynamic GOV*:

H.264/H.265 with LBR Rate Control

The following options are available if you select *LBR Rate Control* and enable *Dynamic GOV*:

H.264/H.265 with LBR Rate Control and Dynamic GOV

2. From the *Resolution* drop-down menu, select the desired resolution. A maximum 25/30 frames per seconds is available when selecting *WDR 2 Shutter (PAL)* or *WDR 2 Shutter (NTSC)*. A maximum 50/60 frames per second is available when selecting *50 fps (PAL)* or *60 fps (NTSC)*. The default setting is *1920 x 1080*.

H.265-Only	
Stream	BNC Support
1920 x 1080	Yes
1280 x 1024	Yes
1280 x 720	Yes
1024 x 768	Yes
800 x 600	Yes
720 x 480 (NTSC) 720 x 576 (PAL)	Yes
640 x 480	Yes

3. From the *Rate Control* drop-down menu, select *CBR*, *VBR*, or *LBR*. The default setting is *VBR*.
 - *CBR* (Constant Bit Rate) is used for setting a constant, maximum bit rate. CBR is not optimal for storage or quality, because it does not allocate enough data for complex sections (which results in degraded quality), and wastes data on simple sections. Choosing a higher bit rate results in better quality, but requires more storage.
 - *VBR* (Variable Bit Rate) files vary the amount of data per time segment. VBR enables a higher bit rate (and therefore requires more storage space) for more complex video or audio, while a lower bit rate and less storage space is allocated to less complex media. VBR files may take longer to encode and might be more problematic for streaming if the maximum bit rate is not set high enough to allow for high instantaneous bit rates.
 - *LBR* (Low Bit Rate) encoding is used primarily for speech at rates below 4kbps. With this encoding, not all of the voice frequency range is encoded. LBR consumes less storage space than CBR or VBR.
4. From the *Profile* drop-down menu, select the H.265 Profile.
 - *High Profile* (HP) provides the best trade-off between storage size and video latency and is the primary profile for HD broadcast applications. It can save 10-30% of the storage cost over Main Profile. However, it may also increase video latency, depending on the stream structure.
 - *Main Profile* (MP) is the default setting. It provides improved picture quality at reduced bandwidths and storage costs.
5. Move the *Frame Rate* slider to the desired setting. The setting range of the MJPEG frame rate is from 1 to 30 (default setting) in NTSC and 1 to 25 (default setting) in PAL. The higher the frame rate, the smoother the motion in the video.
6. Move the *Bit Rate* slider to the desired setting between 1-10240. The default setting is 4096. The higher the bit rate, the better the image quality. Set the maximum bit rate high enough to allow for a high instantaneous bit for more complex video. A higher bit rate consumes more storage space.
7. Move the *GOV Length* slider to a value between 0-4095. The setting determines the frame structure (I-frames and P-frames) for saving bandwidth in a video stream. A longer GOV means decreasing the frequency of I-frames. The default setting is 50.

8. Move the *Encoding Priority* slider to a value between 1 (low bit rate) to 10 (high picture quality). This function enables the user to adjust the quality of the picture along a single axis. The default is 7. Available only with VBR Rate Control.
9. From the *Compression* drop-down menu, select *Hi*, *Mid*, or *Low*. Low produces the highest image quality, but increases the file size. High produces the lowest image quality, but decreases the file size. The default setting is *High*. Available only with LBR Rate Control.
10. From the *Dynamic GOV* drop-down menu, select *Enabled* or *Disabled*. The default setting is *Disabled*. Available only with LBR Rate Control.
11. If you select *Enabled*, move the *Max. GOV* slider to a value between 0-255. The default setting is 255. Available only with LBR Rate Control.
12. Click **SAVE** or **RESET**.

5.6.1.1.2 Single-Stream H.264

The options for implementing single-stream H.264 compression are the same as implementing [single-stream H.265 compression](#).

5.6.1.1.3 Single-Stream MJPEG

To implement single-stream MJPEG compression

1. From the *Encode Type* drop-down menu, select *MJPEG*. The section expands.



MJPEG Compression Options

2. The following resolutions are available. A maximum 25/30 frames per seconds is available when selecting *WDR 2 Shutter (PAL)* or *WDR 2 Shutter (NTSC)*. A maximum 50/60 frames per second is available when selecting *50 fps (PAL)* or *60 fps (NTSC)*. The default setting is *1920 x 1080*.

MJPEG-Only	
Stream	BNC Support
1920 x 1080	Yes
1280 x 1024	Yes
1280 x 720	Yes
1024 x 768	Yes
800 x 600	Yes
720 x 576 (PAL) 720 x 480 (NTSC)	Yes
640 x 480	Yes

3. From the *Q Factor* drop-down menu, select the desired value. A higher value implies higher bit rates and higher visual quality. The default setting of the MJPEG Q factor is 35. The setting range is from 1 to 70. Click **SAVE** to confirm the setting.
4. Move the *Frame Rate* slider to the desired setting. The setting range of the MJPEG frame rate is from 1 to 30 (default setting) in NTSC and 1 to 25 (default setting) in PAL.
5. Click **SAVE** or **RESET**.



Note:

Images can be sent by FTP or email only when MJPEG steaming is selected as one of the streams.

5.6.1.1.4 Dual-Stream

From the *Resolution* drop-down menu, select the desired resolution. A maximum 25/30 frames per seconds is available when selecting *WDR 2 Shutter (PAL)* or *WDR 2 Shutter (NTSC)*. A maximum 50/60 frames per second is available when selecting *50 fps (PAL)* or *60 fps (NTSC)*. The default setting is *1920 x 1080*.



Note:

An analog video output is supported in dual-stream mode on 1920 x 1080 when the second stream is D1 or lower.

H.265/H.264/MJPEG + H.265/H.264/MJPEG	
Stream 1	Stream 2
1920 x 1080	1920 x 1080
	1280 x 1024
	1280 x 720
	1024 x 768
	800 x 600
	720 x 576 (PAL) 720 x 480 (NTSC)
	640 x 480
	352 x 288 (PAL) 352 x 240 (NTSC)
	320 x 240

H.265/H.264/MJPEG + H.265/H.264/MJPEG	
Stream 1	Stream 2
1280 x 1024	1920 x 1080
	1280 x 1024
	1280 x 720
	1024 x 768
	800 x 600
	720 x 576 (PAL) 720 x 480 (NTSC)
	640 x 480
	352 x 288 (PAL) 352 x 240 (NTSC)
	320 x 240
1280 x 720	1920 x 1080
	1280 x 1024
	1280 x 720
	800 x 600
	720 x 576 (PAL) 720 x 480 (NTSC)
	640 x 480
	352 x 288 (PAL) 352 x 240 (NTSC)
	320 x 240 (25/30 fps)
1024 x 768	1920 x 1080
	1280 x 1024
	1024 x 768
	800 x 600
	720 x 576 (PAL) 720 x 480 (NTSC)
	640 x 480
	352 x 288 (PAL) 352 x 240 (NTSC)
	320 x 240

H.265/H.264/MJPEG + H.265/H.264/MJPEG	
Stream 1	Stream 2
800 x 600	1920 x 1080
	1280 x 1024
	1024 x 768
	800 x 600
	720 x 576 (PAL) 720 x 480 (NTSC)
	640 x 480
	352 x 288 (PAL) 352 x 240 (NTSC)
	320 x 240
720 x 576 (PAL) 720 x 480 (NTSC)	1920 x 1080
	1280 x 1024
	1024 x 768
	800 x 600
	720 x 576 (PAL) 720 x 480 (NTSC)
	640 x 480
	352 x 288 (PAL) 352 x 240 (NTSC)
	320 x 240
640 x 480	1920 x 1080
	1280 x 1024
	1024 x 768
	800 x 600
	720 x 576 (PAL) 720 x 480 (NTSC)
	640 x 480
	352 x 288 (PAL) 352 x 240 (NTSC)
	320 x 240 (25/30 fps)

5.6.1.1.5 Triple-Stream

From the *Resolution* drop-down menu, select the desired resolution. Maximum 25/30 frames per seconds is available when selecting *WDR 2 Shutter (PAL)* or *WDR 2 Shutter (NTSC)*. Maximum 50/60 frames per second is available when selecting *50 fps (PAL)* or *60 fps (NTSC)*. The default setting is *1920 x 1080*.



Note:

The default bit rate for Stream 1 and Stream 2 is 4096 bps. The default bit rate for Stream 3 is 2048 bps.

H.265/H.264/MJPEG + H.265/H.264/MJPEG + H.265/H.264/MJPEG		
Stream 1	Stream 2	Stream 3
1920 x 1080	1920 x 1080	1920x1080 - 320x240
	1280 x 1024	
	1280 x 720	
	1024 x 768	
	800 x 600	
	720 x 576 (PAL) 720 x 480 (NTSC)	
	640 x 480	
	352 x 288 (PAL) 352 x 240 (NTSC)	
	320 x 240	
1280 x 1024	1920 x 1080	1920x1080 - 320x240
	1280 x 1024	
	1280 x 720	
	1024 x 768	
	800 x 600	
	720 x 576 (PAL) 720 x 480 (NTSC)	
	640 x 480	
	352 x 288 (PAL) 352 x 240 (NTSC)	
	320 x 240	

H.265/H.264/MJPEG + H.265/H.264/MJPEG + H.265/H.264/MJPEG		
Stream 1	Stream 2	Stream 3
1280 x 720	1920 x 1080	1920x1080 - 320x240
	1280 x 1024	
	1280 x 720	
	800 x 600	
	720 x 576 (PAL) 720 x 480 (NTSC)	
	640 x 480	
	352 x 288 (PAL) 352 x 240 (NTSC)	
	320 x 240	
	320 x 240	
1024 x 768	1920 x 1080	1920x1080 - 320x240
	1280 x 1024	
	1024 x 768	
	800 x 600	
	720 x 576 (PAL) 720 x 480 (NTSC)	
	640 x 480	
	352 x 288 (PAL) 352 x 240 (NTSC)	
	320 x 240	
	320 x 240	
800 x 600	1920 x 1080	1920x1080 - 320x240
	1280 x 1024	
	1024 x 768	
	800 x 600	
	720 x 576 (PAL) 720 x 480 (NTSC)	
	640 x 480	
	352 x 288 (PAL) 352 x 240 (NTSC)	
	320 x 240	
	320 x 240	

H.265/H.264/MJPEG + H.265/H.264/MJPEG + H.265/H.264/MJPEG		
Stream 1	Stream 2	Stream 3
720 x 576 (PAL) 720 x 480 (NTSC)	1920 x 1080	1920x1080 - 320x240
	1280 x 1024	
	1024 x 768	
	800 x 600	
	720 x 576 (PAL) 720 x 480 (NTSC)	
	640 x 480	
	352 x 288 (PAL) 352 x 240 (NTSC)	
	320 x 240	
640 x 480	1920 x 1080	1920x1080 - 320x240
	1280 x 1024	
	1024 x 768	
	800 x 600	
	720 x 576 (PAL) 720 x 480 (NTSC)	
	640 x 480	
	352 x 288 (PAL) 352 x 240 (NTSC)	
	320 x 240	

5.6.1.1.6 Quad-Stream

From the *Resolution* drop-down menu, select the desired resolution. A maximum 25/30 frames per seconds (PAL/NTSC) is available when selecting *WDR 2 Shutter (PAL)* or *WDR 2 Shutter (NTSC)*. A maximum 50/60 frames per second (PAL/NTSC) is available when selecting *50 fps (PAL)* or *60 fps (NTSC)*. The default setting is *1920 x 1080*.



Note:

The default bit rate for Stream 1 and Stream 2 is 4096 bps. The default bit rate for Stream 3 and Stream 4 is 2048 bps.

H.265/H.264/MJPEG + H.265/H.264/MJPEG + H.265/H.264/MJPEG + H.265/H.264/MJPEG			
Stream 1	Stream 2	Stream 3	Stream 4
1920 x 1080	1920 x 1080	1920x1080 - 320x240	1920x1080 - 320x240
	1280 x 1024		
	1280 x 720		
	1024 x 768		
	800 x 600		
	720 x 576 (PAL) 720 x 480 (NTSC)		
	640 x 480		
	352 x 288 (PAL) 352 x 240 (NTSC)		
	320 x 240		
	1920 x 1080		
1280 x 1024			
1280 x 720			
1024 x 768			
800 x 600			
720 x 576 (PAL) 720 x 480 (NTSC)			
640 x 480			
352 x 288 (PAL) 352 x 240 (NTSC)			
320 x 240			
1920 x 1080	1920x1080 - 320x240	1920x1080 - 320x240	
1280 x 1024			
1280 x 720			
1024 x 768			
800 x 600			
720 x 576 (PAL) 720 x 480 (NTSC)			
640 x 480			
352 x 288 (PAL) 352 x 240 (NTSC)			
320 x 240			

H.265/H.264/MJPEG + H.265/H.264/MJPEG + H.265/H.264/MJPEG + H.265/H.264/MJPEG			
Stream 1	Stream 2	Stream 3	Stream 4
1024 x 768	1920 x 1080	1920x1080 - 320x240	1920x1080 - 320x240
	1280 x 1024		
	1280 x 720		
	1024 x 768		
	800 x 600		
	720 x 576 (PAL) 720 x 480 (NTSC)		
	640 x 480		
	352 x 288 (PAL) 352 x 240 (NTSC)		
	320 x 240		
	800 x 600		
1280 x 1024			
1280 x 720			
1024 x 768			
800 x 600			
720 x 576 (PAL) 720 x 480 (NTSC)			
640 x 480			
352 x 288 (PAL) 352 x 240 (NTSC)			
320 x 240			
720 x 576 (PAL) 720 x 480 (NTSC)		1920 x 1080	1920x1080 - 320x240
	1280 x 1024		
	1280 x 720		
	1024 x 768		
	800 x 600		
	720 x 576 (PAL) 720 x 480 (NTSC)		
	640 x 480		
	352 x 288 (PAL) 352 x 240 (NTSC)		
	320 x 240		

H.265/H.264/MJPEG + H.265/H.264/MJPEG + H.265/H.264/MJPEG + H.265/H.264/MJPEG			
Stream 1	Stream 2	Stream 3	Stream 4
640 x 480	1920 x 1080	1920x1080 - 320x240	1920x1080 - 320x240
	1280 x 1024		
	1280 x 720		
	1024 x 768		
	800 x 600		
	720 x 576 (PAL) 720 x 480 (NTSC)		
	640 x 480		
	352 x 288 (PAL) 352 x 240 (NTSC)		
	320 x 240		
352 x 288 (PAL) 352 x 240 (NTSC)	1920 x 1080	1920x1080 - 320x240	1920x1080 - 320x240
	1280 x 1024		
	1280 x 720		
	1024 x 768		
	800 x 600		
	720 x 576 (PAL) 720 x 480 (NTSC)		
	640 x 480		
	352 x 288 (PAL) 352 x 240 (NTSC)		
	320 x 240		
320 x 240	1920 x 1080	1920x1080 - 320x240	1920x1080 - 320x240
	1280 x 1024		
	1280 x 720		
	1024 x 768		
	800 x 600		
	720 x 576 (PAL) 720 x 480 (NTSC)		
	640 x 480		
	352 x 288 (PAL) 352 x 240 (NTSC)		
	320 x 240		

5.6.2 Video Rotation

The **Video Rotation** screen enables you to flip the video and select the rotation angle.

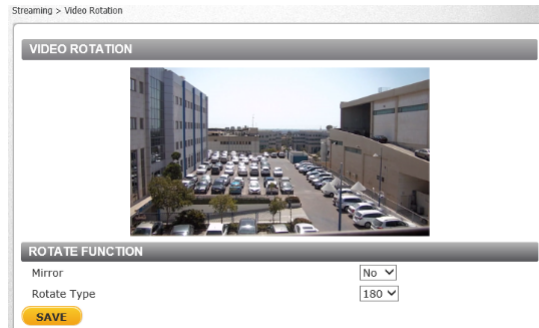

Video Rotation Screen

From the *Mirror* drop-down menu, select *Yes* or *No*. *Yes* reverses the image along its vertical axis.



Source Image Before Reversing the Image



Image after Reversal

From the *Rotate Type* drop-down menu, select 0, 90, 180, or 270 (degrees).

- 0 – The image does not rotate.
- 90 – The image rotates 90° clockwise (to the right).
- 180 – The image rotates 180° counter-clockwise (to the left).
- 270 – The image rotates 90° counter-clockwise (to the left).

Click **SAVE** to confirm the settings.

5.6.3 Video Text Overlay

The **Video Text Overlay** screen enables you configure settings for the text displayed over the live video.



Select the relevant checkbox for the data to include in the on-screen display:

Overlay Type

- *Include Date & Time* – Display the date and time.
- *Include Subtitle* – When this checkbox is selected, enter the string that you wish to display in the text box that opens.
- *Include Azimuth* – When this checkbox is selected, the camera's azimuth is displayed in the overlay.
- *Include Text String* – When this checkbox is selected, enter the string that you wish to display in the text box that opens.
- *Include Image* – When this checkbox is selected, an image, such as a logo, is displayed in the overlay.
- *Include Zoom Ratio* – When this checkbox is selected, the selected zoom is displayed in the overlay.

Click **SET** when finished.

Text Overlay Setting

- *Text Overlay Color* – From the drop-down menu, select the desired color.
- *Text Overlay Size* – From the drop-down menu, select the desired text size.

Click **SET** when finished.

Image Overlay Setting

- *Image Transparency* – Select a number from 0-255. The default is 255. The lower the value, the more transparent the image will be. Click **SET** when finished.



Note:

The file must be saved as an 8-bit .bmp file. The length should be a multiple of 32 (for example, 320 pixels) and the width should be a multiple of 4 (for example 40 pixels). The maximum resolution of the image should not exceed 32,768 pixels.

- *Image Upload* – Select a file to upload. Then click **UPLOAD**.

Users can select the items to display data including date/time/text on the Live Video pane. The maximum length of the string is 20 alphanumeric characters.

Click **SAVE** to confirm the settings.

5.6.4 Video OCX Protocol

From the **Video OCX Protocol** page, you can select various protocols for streaming media over the network. In the case of multicast networking, select *Multicast mode*.

Video OCX Protocol Screen

The screen includes the following settings:

- *RTP over UDP*
- *RTP over RTSP (TCP)*
- *RTSP over HTTP*
- *MJPEG over HTTP*
- *Multicast mode* – For Stream 1,2,3, and 4 (where applicable), enter the following details: *Video Address, Port, and TTL*. Also enter the *Multicast Stream Audio Address*.

**Note:**

The TTL (Time to Live) value instructs the network router whether or not to discard a packet and is reduced every time the datagram is forwarded to another router. The packet is discarded if the TTL reaches 0. The recommended value is 64.

Click **SAVE** to confirm the settings.

5.6.5 Audio

From the **Audio** screen you can select the Transmission Mode, Server Gain, Bit Rate, and enable or disable storage of the audio recording.

Audio Screen

Transmission Mode

- *Full-duplex (Talk and listen simultaneously)* – In the Full-duplex mode, the local and remote sites can communicate with each other simultaneously, i.e. both sites can speak and be heard at the same time.
- *Half-duplex (Talk or listen, not at the same time)* – In the Half-duplex mode, the local or remote site can only talk or listen to the other site at one time.
- *Simplex (Talk only)* – In the Talk only Simplex mode, the local/remote site can only talk to the other site.
- *Simplex (Listen only)* – In the Listen only Simplex mode, the local/remote site can only listen to the other site.
- *Disable* – Select this option to turn off the audio transmission function.

Server Gain Setting

Set the audio input/output gain levels for sound amplification. The sound will be turned off if the input or output gain is set to *Mute*.

- The audio input gain is adjustable from 1-10. The default setting is 3.
- The audio output gain is adjustable from 1-6. The default setting is 3.

Bit Rate

Selectable audio transmission bit rate include 16 kbps (G.726), 24 kbps (G.726), 32 kbps (G.726), 40 kbps (G.726), μ -law (G.711), a-law (G.711), AAC, PCM (128 kbps), PCM (256 kbps), PCM (384 kbps), and PCM (768 kbps). Both μ LAW and ALAW signify 64 kbps, but in different compression formats. A higher bit rate enables higher audio quality, but requires higher bandwidth. The default setting is *uLAW*.



Note:

Latitude does not support G.726.

Click **SAVE** to confirm the settings.

Recording to Storage

This function enables recording of the audio on the local SD / microSDXC card and on the NAS. The *Recording to Storage* function may be enabled or disabled in the **Audio** screen. The default setting is *Disable*.



Note:

This function works only if the *Recording to Storage* option has been selected or if the *Schedule* option has been set.

Click **SAVE** to confirm the settings.

5.7 Camera Tab

From the **Camera** tab, the administrator can adjust camera settings from the following tabs:

[Exposure](#) [Picture Adjustment](#) [Advanced Picture Settings](#) [IR Function](#) [Misc.](#)

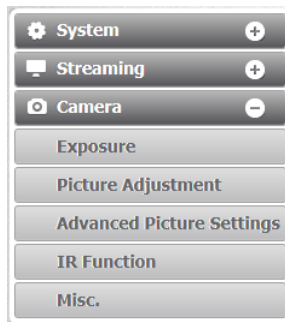

Camera Section Tabs

5.7.1 Exposure Screen

The **Exposure** screen is used to configure lens settings and exposure modes. The exposure is the amount of light received by the image sensor and is determined by the amount of exposure by the sensor (shutter speed), and other exposure parameters.

Administrators may either allow the camera to automatically select an exposure level using a programmed algorithm or choose the level themselves. The smaller the number (the higher the shutter speed) that the administrator selects, the lower the exposure level and vice versa. The configurable settings depend on the selected exposure mode.

The screenshot shows the 'EXPOSURE MODE' configuration interface. It features a 'Max Gain' dropdown set to '3'. There are three main exposure modes selected with radio buttons: 'Auto Iris', 'P-Iris Priority', and 'Iris Priority'. Each mode has its own set of parameters: 'Auto Iris' and 'Iris Priority' both have a 'Min Shutter Speed' dropdown set to '1/4'. 'P-Iris Priority' includes an 'Iris Size Setting' with 'Auto Detect' and 'Manual' options, and a 'Min Shutter Speed' dropdown set to '1/4'. 'Auto Shutter' has a 'Min Shutter Speed' dropdown set to '1/4'. 'Shutter Priority' has a 'Min Shutter Speed' dropdown set to '1/30'. 'Manual Mode' has a 'Shutter Speed' dropdown set to '1/60', an 'Iris Size' dropdown set to '6', and a 'Gain' dropdown set to 'Off'.

Six exposure settings are available:

- [Auto Iris](#)
- [P-Iris Priority](#)
- [Iris Priority](#)
- [Auto Shutter](#) (default)
- [Shutter Priority](#)
- [Manual Mode](#)

For each exposure setting, from the *Max Gain* drop-down menu, select *Off*, *1*, *2*, or *3*.

5.7.1.1 Auto Iris Mode

Auto Iris mode sets a fixed exposure while other parameters can change. In the *Exposure* section, configure the following setting:

- *Min Shutter Speed* – Select a suitable shutter speed according to the environmental luminance. The following table displays the options:

Auto Iris Min Shutter Speed	
PAL	NTSC
1/25	1/30
1/12	1/15
1/6	1/8
1/3	1/4
1/1.5	1/2
-	1



Caution:

Using a slow shutter speed causes moving objects to be blurred.

Attention:

L'utilisation de vitesses d'obturation faibles peut rendre les objets en mouvement flous.

5.7.1.2 P-Iris Priority Mode

In *P-iris Priority* mode, the iris does not adjust, regardless of the light level. If, however, the light level goes below the P-iris setting, the iris will fully open automatically to the optimal iris exposure if the *Auto Detect* radial button is selected.

The following settings are available:

- *Iris Size Setting* – Select the following buttons



The minus (-) button closes the iris.



The plus (+) button opens the iris.

- *Auto Detect* – Select the radial button to enable the iris to open to its optimal exposure if the lighting level falls below the set P-iris level.
- *Min Shutter Speed* – When selecting this mode, the camera's shutter speed automatically achieves a consistent video output level. Users can select a suitable shutter speed according to the environmental luminance.

The following table lists the options:

P-Iris Priority Min Shutter Speed	
PAL	NTSC
1/25	1/30
1/12	1/15
1/6	1/8
1/3	1/4
1/1.5	1/2
-	1

5.7.1.3 Iris Priority Mode

In this mode, the iris value is fixed, while gain and shutter speed vary automatically accordingly.

The following settings are available:

- *Iris Size* – The iris size is adjustable from 0 to 9 or *Full Open*. The higher the iris size, the lower the shutter speed should be.

- *Min Shutter Speed* – When selecting this mode, the shutter is completely open and the exposure priority is given to the iris. Shutter speed and AGC circuit function automatically in cooperating with the iris to achieve a consistent exposure output.

The following table lists the options:

Iris Priority Min Shutter Speed	
PAL	NTSC
1/25	1/30
1/12	1/15
1/6	1/8
1/3	1/4
1/1.5	1/2
-	1

5.7.1.4 Auto Shutter Mode

Auto Shutter mode is the default. *Auto Shutter* mode opens the shutter completely. Shutter speed and the AGC circuit function automatically in cooperating with the iris to achieve a consistent exposure output. The exposure priority is given to the iris. This mode is recommended to be used in indoor environments involving mixed lighting sources where the main source is fluorescent lighting combined with natural light that enters the scene through windows and other exposed areas.

In the *Exposure* section, configure the following settings:

- *Min Shutter Speed* – Select a suitable shutter speed according to the environmental luminance. The following table displays the options:

Auto Shutter Min Shutter Speed			
PAL	NTSC	PAL	NTSC
1/425	1/500	1/50	1/60
1/300	1/350	1/25	1/30
1/215	1/250	1/12	1/15
1/150	1/180	1/6	1/8
1/120	1/120	1/3	1/4
1/100	1/100	1/1.5	1/2
1/75	1/90	-	1

5.7.1.5 Shutter Priority Mode

Shutter Priority mode is used to set a fixed exposure while other parameters can change. Continue to configure the settings in the *Exposure* section:

Shutter Priority Speed	
PAL	NTSC
1/425	1/500

Shutter Priority Speed	
1/300	1/350
1/215	1/250
1/150	1/180
1/120	1/120
1/100	1/100
1/75	1/90
1/50	1/60
1/25	1/30

5.7.1.6 Manual Mode

Manual mode is used generally where light levels are fixed and the auto settings do not provide the perfect exposure. It is recommended for scenes such as indoor scenes, where there is a fixed lighting contrast and a constant, precise exposure is required.

Manual Mode opens the iris completely with a fixed gain to a fixed shutter speed. Users can select a suitable shutter speed according to the environmental luminance. Increasing the value of the fixed shutter increases the amount of light entering the sensor. This allows a brighter and more detailed image. Similarly, utilizing gain and increasing its level increases the sensitivity of the image sensor, which brightens the image and add details. This increases the level of noise in the image.

In Manual Mode, the administrator can select a fixed shutter speed and gain from drop-down menus. The smaller the shutter speed number (the higher the shutter speed), the lower the exposure level. The higher the gain, the brighter the picture.

The following settings are available:

- *Shutter Speed* – Select the fixed shutter speed according to the environmental luminance. The following table lists the options:

Manual Mode Fixed Shutter Speeds			
PAL	NTSC	PAL	NTSC
1/10000	1/10000	1/100	1/100
1/3500	1/3000	1/75	1/90
1/2500	1/2000	1/50	1/60
1/1250	1/1000	1/25	1/30
1/600	1/725	1/12	1/15
1/425	1/500	1/6	1/8
1/300	1/350	1/3	1/4
1/215	1/250	1/1.5	1/2
1/150	1/180	-	1
1/120	1/120	-	

- *Iris Size* – The iris size is adjustable from 0 to 9 or *Full Open*. The higher the iris size, the lower the shutter speed should be.

- **Gain** – A nominal video signal level is usually 1-volt peak-to-peak for composite video, 0.7 volts for component or RGB video, or 0.3 volts for the chrominance subsection, at which level a fully saturated picture is transmitted to the acceptor. However, for cases where the video signal is attenuated, a low-noise, high-gain analog amplifier is built into quality video processing equipment. This amplifier provides video gain control whereby the video signal can be boosted or reduced. Dark pictures caused by low level lighting are easily adjusted. The *Gain* drop-down menu turns the video gain *Off* or moves it in steps from 1 to 9.

5.7.2 Picture Adjustment

Adjustment of some qualities of the video is made possible by selecting **Picture Adjustment** in the **Camera** tab. Brightness, Sharpness, Contrast, Saturation and Hue may all be adjusted via drop-down menus from this window, as shown below.



The screenshot shows a window titled "PICTURE ADJUSTMENT" with five rows of settings, each with a label and a dropdown menu:

Setting	Value
Brightness	+9
Sharpness	+5
Contrast	Default
Saturation	+5
Hue	Default

Picture Adjustment Screen

Brightness

You can adjust the image's brightness by adjusting this parameter. Select from the range between -12 to +13. To increase video brightness, select a larger number. The default setting is *DEFAULT*. The setting is applied automatically.

Sharpness

Increasing the sharpness level can make the image look sharper, especially enhancing the object's edge. Select from the range between 0 to +15. The default setting is *DEFAULT*. The setting is applied automatically.

Contrast

Camera image contrast level is adjustable. Select from a range of -6 to +19. The default setting is *DEFAULT*. The setting is applied automatically.

Saturation

Camera image saturation level is adjustable. Select from a range of -6 to +19. The default setting is *DEFAULT*. The setting is applied automatically.

Hue

Camera image hue level is adjustable: select from a range of -12 to +13. The default setting is *DEFAULT*. The setting is applied automatically.

5.7.3 Advanced Picture Settings

The **Advanced Picture Settings** screen is used configuring the following settings:

[White Balance](#)

[Backlight
Compensation](#)

[WDR Function](#)

[Noise Reduction Settings](#)

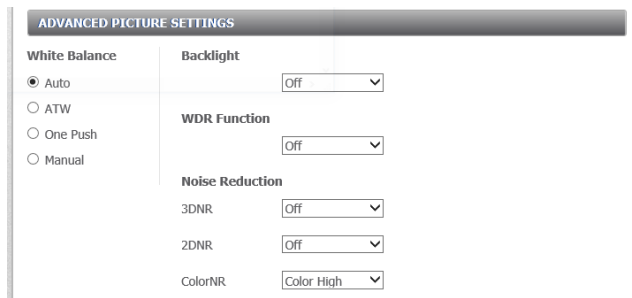

Advanced Picture Settings Screen with Backlight Compensation

5.7.3.1 White Balance

A camera needs to find a reference color temperature as a way of measuring the quality of a light source for calculating all other colors. The unit for measuring this ratio is in Kelvin (°K) degrees. You can select one of the White Balance control modes according to the operating environment. The table below shows the color temperature of some light sources for reference.

Light Sources	Color Temperature (in K°)
Cloudy Sky	6,000 to 8,000
Noon Sun and Clear Sky	6,500
Household Lighting	2,500 to 3,000
75-watt Bulb	2,820
Candle Flame	1,200 to 1,500

Select one of the following white balance modes:

- *Auto* – The Auto Balance White mode computes the white balance value output using color information from the entire screen. It is suitable for an environment with a light source color temperature in the range of approximately 2,700 ~ 7,500K. This is the default setting.
- *ATW (Auto Tracking White Balance)* – The Auto Tracking White Balance function automatically adjusts the white balance in a scene while temperature color is changing. The ATW Mode is suitable for an environment with a light source color temperature in the range of approximately 2500 ~ 10,000K. This is the default setting.
- *One Push* – This button activates the factory-optimized setting for white balance. This setting may not be ideal for every lighting environment.
- *Manual* – In this mode, you can manually change the white balance value. You can select a number between 0 – 127 for either/both Rgain and Bgain to increase the red and/or blue luminance.

The setting is applied automatically.

5.7.3.2 Backlight Compensation

Backlight compensation is used in images where a bright light source is behind the subject of interest. Without backlight compensation, the subject would normally appear in silhouette. The backlight function of the camera allows it to adjust the exposure of the entire image to properly expose the subject in the foreground.

Backlight compensation is available only when the TV System is set to *50 fps (PAL)* or *60 fps (NTSC)* on the **Camera > Misc.** screen and the WDR Function is set to *Off* on the **Advanced Picture Settings** screen. Otherwise, this function is not displayed on this screen.

From the *Backlight* drop-down menu, select *On* or *Off*. The default setting is *Off*. The setting is applied automatically.

5.7.3.3 WDR Function

By default, the camera utilizes digital Wide Dynamic Range (dWDR), which improves the image quality and amount of details in high contrast scenes. Such scenes combine areas with different lighting conditions, where some areas are very bright and others are dark. If this function was not used, the image either would be overexposed or too bright in bright areas and completely dark in dark areas. Digital WDR helps to improve image quality by producing a larger amount of details in both the dark and bright areas of the image.

The *WDR function* setting is adjustable among *Off*, *Low*, *Mid* and *Hi*. A higher level of WDR represents wider dynamic range, so that the IP camera can capture a greater scale of brightness. The default setting is *Low*. The setting is applied automatically.

**Note:**

1. When enabling Shutter WDR, be sure to select the corresponding PAL or NTSC *WDR 2 Shutter* setting from the *TV System* drop-down menu on the [Camera > Misc.](#) screen.
2. Shutter WDR (True WDR) can be enabled from the [Camera > Misc.](#) screen as an alternative to digital WDR. Shutter WDR is recommended for most lighting conditions.
3. When the frequency of a light source around the camera (including reflected light) is closely synced with the Shutter WDR operation, a pixelization effect may appear. In these cases, it is advised to use non-shutter WDR modes (such as NTSC 60). To change the mode, open the web page and go to Settings > Camera > Misc. Select the appropriate TV system (NTSC 60/PAL 50). The camera will reboot. If the camera is attached to a VMS, rediscover the camera after initialization.

5.7.3.4 Noise Reduction Settings

The noise reduction function consists of three settings:

- 3DNR
- 2DNR (Default setting)
- ColorNR

Noise reduction settings are used to reduce or eliminate artifacts that can limit the ability to positively identify an object. There are two types of noise: luminance and color (chroma) noise.

3DNR and 2DNR settings reduce luminance noise, which is composed of dots of various brightness levels (black, white and gray) luminance noise contains dots of varying brightness levels (black, white, and gray). It is not recommended to completely eliminate luminance noise, which can result in unnatural images. 3DNR and 2DNR settings should be configured after configuring ColorNR.

3DNR

3DNR (3D Noise Reduction) provides superior noise reduction and is recommended for use in in extra low-light conditions. It is especially useful for reducing blur with moving objects. The 3DNR function reduces image noise/snow in low-light conditions by comparing adjacent frames. A higher level of 3DNR generates relatively enhanced noise reduction, although it creates more motion blur than 2DNR on moving objects.

The noise reduction is adjustable from *Off*, *3DNR Low*, *3DNR Mid*, and *3DNR Hi*. The setting is applied automatically.

2DNR

2DNR (2D Noise Reduction) analyzes individual frames pixel by pixel and frame by frame to eliminate environmental noise and deliver optimized image quality, especially in low-light conditions. 2DNR tends to produce superior results for moving objects when applied to areas in the field of view where movement is present. However, it is less precise than 3DNR.

Settings include *On* and *Off*. The default setting is *On*. The setting is applied automatically.

ColorNR

The *ColorNR* setting controls the noise displayed as red, green and blue dots that are visible between light and dark areas. Four settings are available: *Off*, *Color Low*, *Color Mid*, and *Color Hi*. The highest setting (*Color Hi*) maximizes the blending of the color noise with the image, effectively removing the dots, while the *Color Low* setting minimizes the blending. The *Off* setting disables this function. The default setting is *Color Hi*. The setting is applied automatically.

5.7.4 IR Function

The IR Function settings control the IR Cut (IRC) filter for electronic day/night operation (*IR mode*). On the CP-6302-31-I model, the IR Function settings also control the camera's IR LED illuminator for use in low-light conditions or at night. * indicates the settings available only on the CP-6302-31-I model.

The screenshot shows the 'IR FUNCTION' settings screen. It contains the following controls:

- IR Mode:** A dropdown menu set to 'Smart'.
- Day/Night Threshold:** Two settings, each with a moon and sun icon and a dropdown menu. The first is set to '7' and the second to '3'.
- IR Compensation:** A dropdown menu set to 'On'.
- IR Heating:** A dropdown menu set to 'Off'.

IR Function Screen

IR Mode

Select an IR mode:

- *Auto* – The camera converts from Day mode (color) to Night mode (monochrome) automatically at nighttime or in low light conditions. When there is sufficient light, the camera converts automatically from Night mode to Day mode.
- *Night* – Use this mode when the light level is low. The IR Cut filter is removed, allowing the camera to deliver clear images in black and white.
- *Day* – Select this mode to turn on the IR Cut filter. The IR Cut filter filters out IR light and allows the camera to deliver high quality images in color.
- **Light Sensor* (default) – IR LEDs are turned on or off depending on the light sensor.
- **Light On* – Activates IR mode (puts camera into monochrome/Night mode). The IR LEDs are continuously illuminated.

- **Light Off* – Deactivates IR mode (puts camera into color/Day mode). The IR LEDs are continuously off.
- *Smart* – Smart mode enhances monochrome/Night mode stability and keeps the camera from switching between Day and Night modes. In this mode, when IR illumination is dominant, the camera decides when to remove the IR Cut filter.
On the 31-I IR model, when the IR Cut filter is on (i.e. monochrome/Night mode), the IR LED illuminator also is activated. This prevents the camera from returning to color/Day mode.



Note:

When video transitions from day-to-night and night-to-day, it can appear off-color. This should resolve itself within a few seconds as the levels of light decrease or increase, respectively.

Day/Night Threshold

Set the threshold at which you want to activate the IR function. The setting is applied automatically.

- For the daytime to nighttime threshold ☀→🌙, from the drop-down list, select a number between 1-9, where 1 is darker and 9 is brighter, or select *Darker* or *Brighter*. The default setting is 7.
- For the nighttime to daytime threshold 🌙→☀, from the drop-down list, select a number between 1-9, where 1 is darker and 9 is brighter, or select *Darker* or *Brighter*. The default setting is 3.

IR Compensation

From the drop-down list, set the IR Compensation to *On* or *Off*. Setting IR Compensation to *On* compensates for the reflection of infrared light emitted from the camera onto reflective objects, thus improving image sharpness and definition. Without IR compensation, objects may appear blurred. The default setting is *On*. The setting is applied automatically.

***IR Heating**

IR Heating allows control over the internal temperature of the camera. **Off** by default. When set to **On**, the camera will maintain operational temperature in particularly cold surroundings.



Note:

1. It is recommended that this feature **only** be used in conditions of **extreme cold**.
2. The camera must have a Zoom MCU version of T2-L34-I0-180724-02 to support this feature. Please contact Teledyne FLIR Support to download this file

5.7.5 Misc. Screen

The **Misc.** screen is used for enabling Digital Zoom and setting the TV System, which determines if other functions can be enabled.

- When the selected TV System is *50 fps (PAL)* or *60 fps (NTSC)*, only the Digital Zoom can be enabled. The unit operates with digital WDR.
- When the selected TV System is *WDR 2 Shutter (PAL)* or *WDR 2 Shutter (NTSC)* and *WDR Function* is enabled (*On*) in the [Advanced Picture Settings](#) screen, you can enable the Image Stabilizer and Shutter (True) WDR. The unit's frame rate is 25/30 fps in this mode. The default setting is *WDR 2 Shutter (NTSC)*.

MISC.

Digital Zoom

Image Stabilizer

Stabilizer

Auto Calibration

Calibrate

TV System

Misc. Screen with True (Multi-Shutter)WDR Enabled



Note:

After changing the TV Setting, the camera resets automatically. Refresh the page to view the new setting. There is no need to log in again.

Digital Zoom

The camera's digital zoom is adjustable from x1 to x30. Select *Off* or *On*. The default setting is *Off*. The setting is applied automatically.

Image Stabilizer

The image stabilizer keeps the image steady and suppresses effects caused by external vibration. Keep the camera still for 3 seconds to ensure calibration accuracy.

From the *Stabilizer* drop-down menu, select *On* to activate the Stabilizer or *Off* to disable it. The default setting is *Off*. The setting is applied automatically.

From the *Auto Calibration* drop-down menu, select *On* to activate Auto Calibration or *Off* to disable it. Auto calibration automatically calibrates the camera when it detects a deviation of dome pivot. The camera constantly aligns itself against vertical and horizontal checkpoints to maintain accurate operation. The default setting is *On*. Click **SET** to calibrate the unit.



Note:

1. Do NOT use PTZ functions when activating manual calibration.
2. The Digital Zoom function and the Zoom Factor function on the [Privacy Mask](#) screen are disabled when the Stabilizer is set to *Off*.
3. When image stabilization is enabled, the video image will be slightly cropped. This is part of the stabilization algorithm as it is processing the image.

TV System Settings

From the drop-down menu, select the video system setting. The setting is applied automatically.

- 60 fps (NTSC)
- 50 fps (PAL)
- WDR 2 Shutter (NTSC) – default setting
- WDR 2 Shutter (PAL)

Selecting *WDR 2 Shutter* enables True (Multi-Shutter) WDR at 25/30 fps (PAL/NTSC). It is recommended to select *WDR 2 Shutter* to solve contrast or changing light issues and to enhance the video display

quality. This function is used to set a fixed exposure while other parameters can change. In this mode, the camera's shutter speed works automatically to achieve a consistent video output level in scenes with high contrast or changing light issues.

When activated, a combination of slow- and fast-exposure shutters creates a new image with a wide dynamic range. The camera's algorithm determines the optimal mix of regions within the scene from the two shutters in order to adjust the wide dynamic range of the scene. If this function was not used, the image either would be overexposed or too bright in bright areas and completely dark in dark areas. Shutter WDR is recommended for most lighting conditions.



5.8 PTZ Tab

The following functions are available from the PTZ tab.

[Preset](#) [Pattern](#) [Auto Pan](#) [Sequence](#) [Home](#) [Tilt Range](#) [Privacy Mask](#)

[PTZ Setting](#) [RS485](#)

Every screen in the **PTZ** section includes the following pushbuttons next to the **Live View** window:

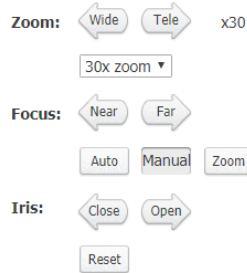

PTZ Pushbuttons

Zoom			<p>Click the Wide or Tele Zoom button to implement continuous zoom adjustment.</p> <p>From the drop-down Zoom menu, select the zoom (1x zoom-30x zoom). The selected zoom is displayed. The default setting is 1.</p>
Focus			<p>Click Manual to adjust focus manually.</p> <p>Use the Near and Far buttons to implement continuous focus adjustment. When selected, the button appears to have been pressed.</p> <p>Click Auto to enable AF mode. In this mode, the camera automatically and continuously maintains focus regardless of zoom or view changes.</p>
Iris			<p>Click Close to close the iris.</p> <p>Click Open to open the iris.</p> <p>Click Reset to reset the iris.</p>

5.8.1 Preset

The **PTZ** tab opens on the **Preset** screen.

Preset Screen

On this screen you can program up to 256 Presets to target a specific view in the Live View pane.

To program a Preset Point

1. Move the cursor to the Live View pane.
2. Left-click and drag the red pointer to the desired position.
3. Adjust the fine zoom/focus ratio.
4. Under *Preset setting*, assign an unused number to the Preset Point from the drop-down menu. Click **PrePage** or **NextPage** for additional numbers.
5. From the *Num* drop-down menu, select a number from 1-10.
6. In the *Name* text box, enter a friendly name for the Preset Point.
7. Click **SET** to save settings.

To move the camera to a Preset position

1. From the *Preset go* drop-down menu, select the desired Preset Point.
2. Use the **PrePage** or **NextPage** buttons located under *Preset setting* for additional numbers. The camera moves to the target position.

To delete a Preset

1. Select the desired Preset Point from the drop-down menu.
2. Click **DELETE** to remove the Preset.

5.8.2 Pattern

From the **Pattern** page, up to four Pattern Lines may be defined. A Pattern Line is a stored route defined through manual adjustment of pan, tilt, and zoom.

Pattern Line Screen

To set up a Pattern Line

1. Select a path number from the *Pattern path* drop-down menu.
2. In the Live View pane, move the cursor to the desired start point of the Pattern path.
3. Use the PTZ controls to set the desired start point view.
4. Click **Record start: SET**.
5. Use the PTZ controls to define the path within the Live View pane.
6. Click **Record end: SET** when finished.

To move the camera along a Pattern Line

1. Under *Pattern run*, select the desired Pattern path from the drop-down menu.
2. Click **RUN**. The camera moves along the recorded Pattern path.

To view the camera in full screen mode as it follows the Pattern Line

1. Move the cursor onto the Live View pane.
2. Right-click and select full screen.
3. Double-click to exit full screen mode.

To stop running a Pattern Line

1. Move the cursor to the Live View pane and move the camera in any direction.

5.8.3 Auto Pan

From the **Auto Pan** page, up to four Auto pan paths may be defined. An Auto pan path scans an area horizontally from left to right or right to left at a user-defined speed.

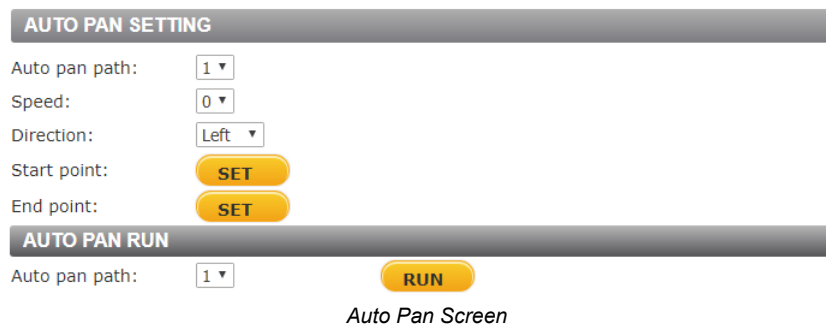

To set up an Auto pan path

1. From the *Auto pan setting* section, select a path number from the *Auto pan path* drop-down list.
2. In the Live View pane, move the camera view to the desired start point and click **Start Point: SET**.



Note:
The zoom ratio at the start point is maintained for the entire Auto pan path.

3. Select a speed setting from the *Speed* drop-down menu, from 0 (low) to 3 (fast).
4. Select a direction for the path from the *Direction* drop-down menu.
5. In the Live View pane, move the camera view to the desired end point. Click **End Point: SET**.

To run an Auto pan path

1. Under *Auto pan run*, select the desired Auto pan path from the drop-down list.
2. Click **RUN**. The camera will move along the defined Auto pan path.

To view the camera in full screen mode as it follows the Pattern Line

1. Move the cursor onto the Live View pane.
2. Right-click and select *Full screen*.
3. Double-click to exit full screen mode.

To stop running an Auto pan path

1. Move the cursor to the Live View pane and move the camera in any direction.

5.8.4 Sequence

The **Sequence** page enables you to define up to eight Sequence lines for the camera image. A Sequence line is an automated series of camera movements from one Preset Point to another, in a pre-determined order, and for configurable time periods. Each Sequence line can contain up to 64 different Preset Points.

The screenshot shows two sections: 'SEQUENCE SETTING' and 'SEQUENCE RUN'. The 'SEQUENCE SETTING' section has a 'Sequence setting' label and an 'EDIT' button. The 'SEQUENCE RUN' section has a 'Sequence line:' label with a dropdown menu showing '1', and a 'GO' button.

Sequence Screen



Note:

Before creating a sequence, you must first define at least two Preset Points. See [Preset](#).

To set up Sequence Line

1. In the *Sequence setting* section, click **EDIT**. The **Sequence Set** screen opens.

The screenshot shows the 'SEQUENCE SET' screen. At the top, there is a 'Sequence line:' dropdown set to '1' and a 'SAVE' button. Below is a table with three columns: 'Preset Name', 'Dwell time[0..127]', and 'Speed[0..14]'. The table has 16 rows. The first three rows are populated with values: Row 1: 1(dv1), 5, 3; Row 2: 2(dv2), 7, 5; Row 3: 3(dv3), 10, 5. Rows 4 through 16 are empty, with the 'Preset Name' column containing '--no setting--'. At the bottom of the table are 'Pre page' and 'Next page' buttons.

Sequence Set Screen

2. Select a Sequence line number from the *Sequence line* drop-down list.
3. Define each Preset Point for the Sequence line in the desired order:
 - a. Select the first Preset Point from the *Preset Name* list. Use the **PrePage** or **NextPage** buttons to navigate between the Sequence preset numbers.
 - b. Specify the Dwell time (between 0 and 127 seconds) for the first Preset Point.
 - c. Specify the camera's Speed (between 0 and 14).
4. Repeat steps a, b, and c for up to 64 Preset Points.
5. Click **SAVE** to save your preset sequence.

To run the camera through a Sequence line

1. From the *Sequence run* section, select the Sequence line from the drop-down list.

2. Click **GO**. The camera moves through each Preset Point sequentially as programmed.

To view the camera in full screen

1. Move the cursor onto the Live View pane.
2. Right-click and select *Full screen*.
3. Double-click to exit *Full screen* mode.

To stop running a Sequence line

1. Move the cursor to the Live View pane and move the camera in any direction.

5.8.5 Home

The **Home** page allows you to specify an operation mode to be activated automatically when the camera is idle for a specified period of time.

The screenshot shows two configuration screens. The top screen, titled 'HOME FUNCTION', has a 'Switch:' label with a dropdown menu set to 'Off' and a yellow 'SET' button. The bottom screen, titled 'HOME SETTING', has three fields: 'Time:' with a text box containing '1' and a range indicator '[1..128Min]'; 'Type:' with a dropdown menu set to 'Preset'; and 'Line:' with a dropdown menu set to '1(dv1)'. A yellow 'SET' button is located below these fields.

Home Screen

To configure Home settings

1. From the *Switch* drop-down menu, select *On* to activate or *Off* to disable the Home function.
2. Click **SET** to save the setting.
3. In the *Time* text box, enter the amount of time (1-128 minutes) that the camera is idle before executing the Home function action.
4. From the *Type* drop-down menu, select the action to perform: *Preset*, *Sequence*, *Auto pan*, or *Pattern*.
5. From the *Line* drop-down menu, select the Preset, Sequence, Auto pan, or Pattern path number.
6. Click **SET** to save the Home settings.

5.8.6 Tilt Range

The **Tilt Range** page allows you to specify the camera's *Tilt Angle*.

The screenshot shows the 'TILT RANGE' configuration screen. It has a section titled 'Angle Setting' with two fields: 'Min:' with a text box containing '0' and a range indicator '[-20..10]'; and 'Max:' with a text box containing '90' and a range indicator '[80..100]'. A yellow 'SET' button is located below these fields.

Tilt Range Screen

To set an angle

1. In the *Min.* text box, enter the minimum tilt angle (from -20° to 10°).
2. In the *Max.* text box, enter the maximum tilt angle (from 80° to 100° if the *Flip* function is not activated on the [PTZ Setting](#) screen, or from 170° to 190° if the *Flip* function is enabled).
3. Click **SET** to save the *Tilt Angle* settings.

5.8.7 Privacy Mask

From the **Privacy Mask** page, you can set up to 20 privacy masks. The Privacy Mask function allows concealment of sensitive portions of the camera image to avoid intrusive monitoring.



Note:

1. The Flip function on the [PTZ Setting](#) screen is automatically disabled when the Privacy Mask function is on.
2. The Zoom Factor function is disabled when the Stabilizer is set to *Off* on the [Camera > Misc.](#) screen.

Privacy Mask Screen

To create a mask

1. From the *Switch* drop-down menu, select *On* to activate or *Off* to disable the Privacy Mask function.
2. Click **SET** to save the setting.
3. From the *Color* drop-down menu, select the desired color for the specified Privacy Mask.
4. Click **SET** to save the setting.
5. In the *Mask* text box, it is possible to create up to 20 masks. Enter the number (1-20) of the programmed Privacy Mask.
6. From the *Zoom Factor* drop-down menu, select *On* or *Off*. If the Zoom Factor is set to lower than 20x and the object is very small, a privacy mask will not be displayed. When Zoom Factor is *On*, the mask is displayed with 20x zoom and higher.
7. Click **ADD** to save the programmed Privacy Mask.
8. To edit a programmed Privacy Mask, select the Privacy Mask and click **EDIT**.

To clear (delete) an existing Privacy Mask

1. From the *Mask* drop-down menu, select the Privacy Mask.
2. Click **CLEAR**.

5.8.8 PTZ Setting

The **PTZ Setting** screen includes a few miscellaneous settings.

PTZ Setting Screen

Flip

You can track an object continuously when it passes under the camera by selecting *M.E.* (Mechanical) or *Image* (Digital Flip) mode from the drop-down list. When *Flip* is enabled, the image is reversed along its horizontal axis. Select *Off* if you do want to use this function (default setting).

- *M.E. mode* – *M.E.* is a standard mechanical operation. As the dome camera tilts to the maximum angle, it pans 180° and then continues tilting to keep tracking objects.
- *Image mode* – In *Image* mode, the camera seamlessly tracks objects digitally. There is an approximately one-second freeze in the image when the video flips.

Click **SET** to confirm the setting.



Note:

1. The Flip setting can only be controlled manually. If a Preset Position or a point for another function (ex. Sequence) is set to a position that can only be reached by Flip motion, it cannot be reached when the Flip function is Off.
2. To tilt the camera within a specific range, such as -10° to +100° or -10° to +190°, set the tilt angle range on the [Tilt Range](#) page. If not specified, the default setting is 90°.
3. The Privacy Mask function is automatically disabled when the Flip function is enabled.

Speed by Zoom (Proportional Pan & Tilt)

Enable this function to automatically adjust by internal algorithm the pan/tilt speed when zooming. From the drop-down list, select *On* or *Off*. Click **SET** to save the setting.

Auto Calibration

Auto Calibration automatically calibrates the camera when a deviation of dome pivot is detected. The camera constantly aligns itself against vertical and horizontal checkpoints to maintain accurate operation. From the drop-down list, select *On* or *Off*. Click **SET** to save the setting.

Set Pan Zero

Set the current camera position as the Pan Zero (due north) point for the camera. Click **SET** to save the setting.

5.8.9 RS485

The **RS485** screen is used for configuring RS-485 connection settings.

RS485

Protocol	<input type="text" value=""/>
Baudrate	<input type="text" value="9600"/>
Data bits	<input type="text" value="8"/>
Parity	<input type="text" value="None"/>
Stop bits	<input type="text" value="1"/>
ID number	<input type="text" value="1"/> (1~254)

RS485 Screen

To configure RS-485 settings

1. From the *Protocol* drop-down menu, select *PelcoD* or *PelcoP*. The default is *PelcoD*.
2. From the *Baudrate* drop-down menu, select the desired baud rate. The default is 2400.
3. The *Data bits* field is disabled.
4. The *Parity* field is disabled.
5. The *Stop bits* field is disabled.
6. In the *ID number* text box, enter the ID number (1-254). The ID number is provided by the camera according to the camera model, protocol and dipswitch settings. The default is 1.
7. Click **SAVE**.

5.9 Log Out

Selecting the **Logout** link on the **Home** page to close the session. The following message appears:

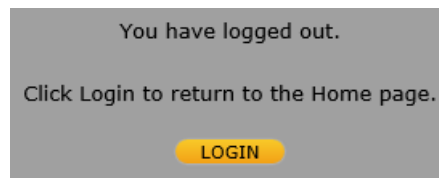

Login Message

Upon clicking **Login**, the **Login** dialog box opens.

6 Appendices

- [Technical Specifications](#)
- [Internet Security Settings](#)
- [Install UPnP Components](#)
- [Installing and Deleting the Web Player](#)
- [Deleting Temporary Internet Files](#)

6.1 Technical Specifications

6.1.1 Accessing Product Information from the Teledyne FLIR Website

Up-to-date resources for the camera, including the camera’s specifications, the Teledyne FLIR Discovery Network Assistant (DNA) software tool, and this guide, are available from the camera’s product details and support pages on [the Teledyne FLIR website](https://www.flir.com).

To access product information from the Teledyne FLIR website:

1. Open <https://www.flir.com/browse/security/> and navigate to [Products > Security > Visible Security Cameras](#).

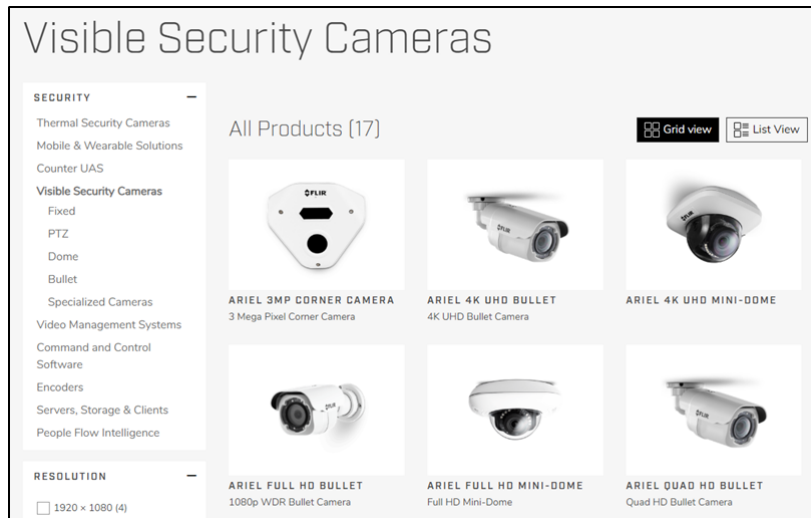

Visible Security Cameras Page on the Teledyne FLIR Website

2. Find and click the camera. The camera’s product details page appears.

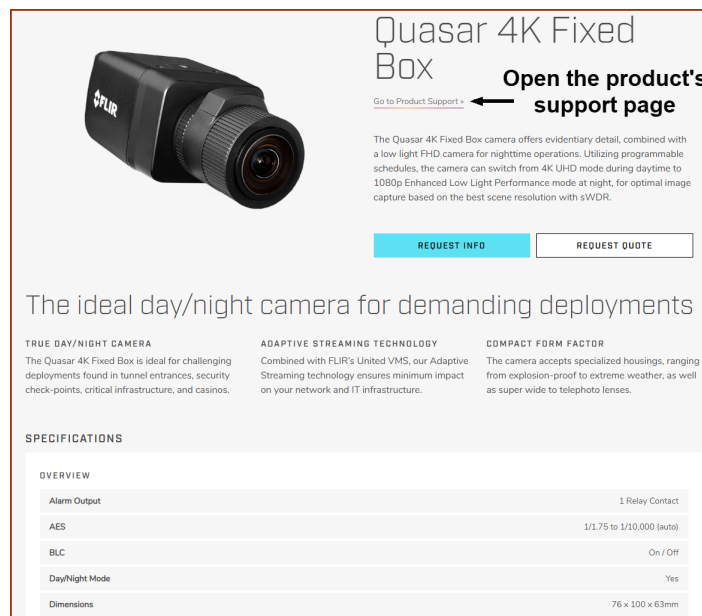

Product Details Page (Example)

To see the camera’s specifications and related content, scroll down.

3. Click **Go to Product Support**. The camera's support page appears.
4. Download product documentation from the Documents tab.

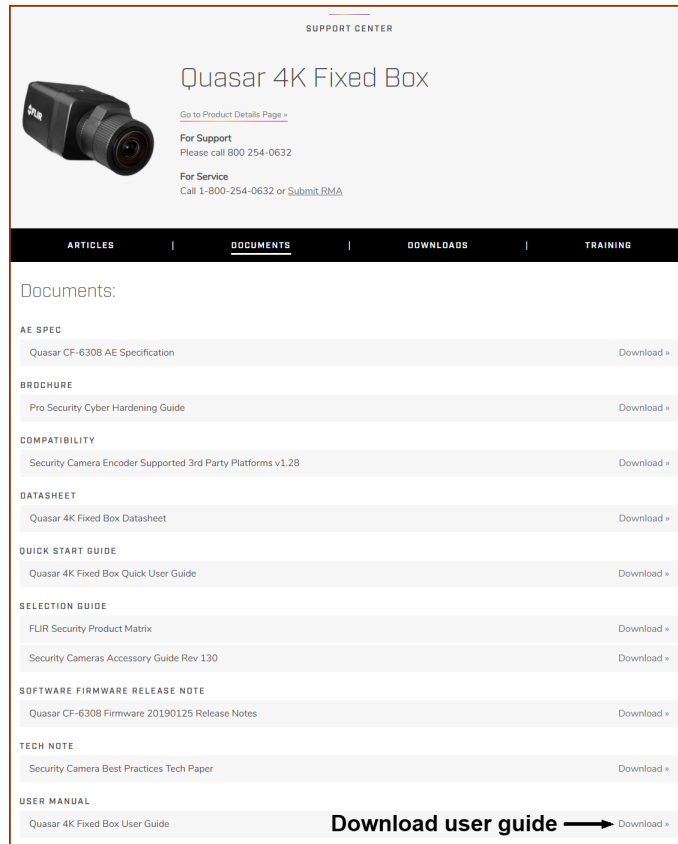

Product Support Page Documents Tab (Example)

5. Download the DNA tool from the Downloads tab.

6.2 Internet Security Settings

If you are using Microsoft Internet Explorer to access the camera's browser-based user interface and ActiveX control installation is blocked, either set Internet security level to default or change ActiveX controls and plug-in settings.

To set the default Internet security level

1. Start Internet Explorer (IE).
2. From the Command Bar toolbar, select **Tools**  and select *Internet Options* from the menu that appears.

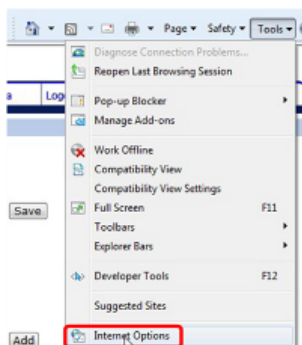

Command Bar Toolbar – Select Internet Options (Win 7, 8, and 8.1)

3. In the **Internet Options** dialog box that appears, select the **Security** tab.
4. Select  **Internet** in *Select a zone to view or change security settings*.
5. If the settings are not defined as default, select *Default Level* and move the *Allowed* levels for this zone slider to *Medium-high* and select **OK**.

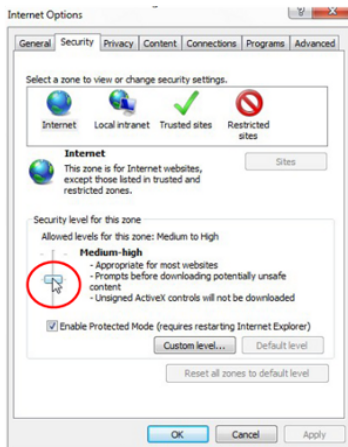

Internet Options > Security Screen

6. Close all browsers and reopen so that the settings take effect.

ActiveX Controls and Plug-in Settings

To create a custom level

1. Start Internet Explorer (IE).
2. From the Command Bar toolbar, select **Tools**  and select *Internet Options* from the menu that appears.

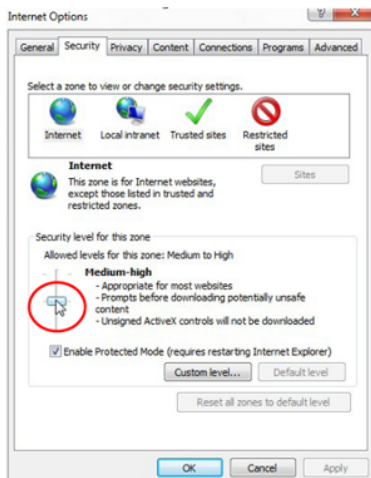

Command Bar Toolbar – Internet Options

3. In the **Internet Options** window that appears, select the **Security** tab.
4. If not already selected, select  **Internet**, then select *Custom Level*.
5. In the dialog that appears, under **ActiveX controls and plug-ins** set ALL the following options (listed below) to **Enable** or **Prompt**:

<ul style="list-style-type: none"> • Automatic prompting for ActiveX controls • Binary and script behaviors • Download signed ActiveX controls • Download using ActiveX controls • Initialize and script ActiveX not marked as safe • Run ActiveX controls and plug-ins • Script ActiveX controls marked safe for scripting 	
--	--



Security Settings-Internet Zone Screen

6. Click **OK** to accept the settings and close the **Security** screen.
7. Click **OK** to close the **Internet Options** screen.
8. Close the browser window and restart IE again to access the camera.

6.3 Install UPnP Components

Follow the instructions below to enable UPnP so that the camera can be discovered and displayed in the *Network and Sharing Center*.

To enable UPnP discovery

1. Click  or  (**Start**) and select *Control Panel*.
2. Click *Network and Internet* (Win 7, 8, or 8.1).

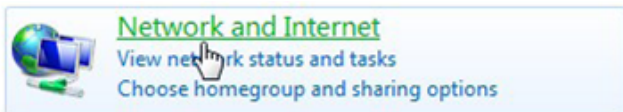

3. Click *Network and Sharing Center* (all OSs).

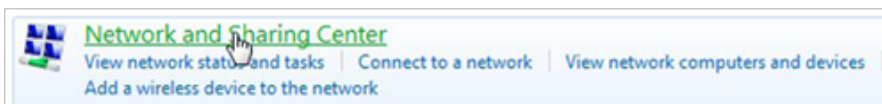

4. Click *Change advanced sharing settings*.

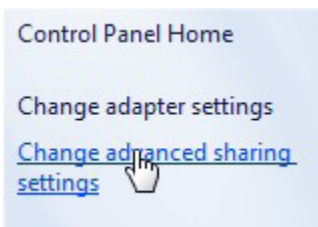

5. Expand the Home or Work node, select *Turn on network discovery*.

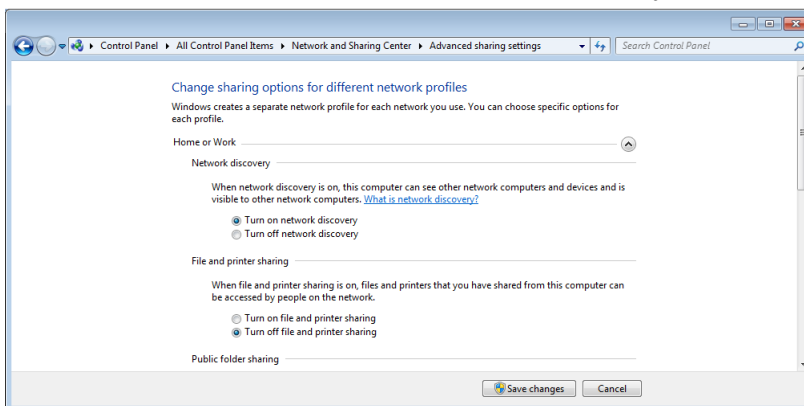

Advanced Sharing Settings Screen



6. Click **Save Changes**.



Note:

Network discovery requires that the DNS Client, Function Discovery Resource Publication, SSDP Discovery, and UPnP Device Host services are started, that network discovery is allowed to communicate through Windows Firewall, and that other firewalls are not interfering with network discovery.

To check that the UPnP Device Host services are running

1. Click  or  (**Start**) and type in the Search programs and files field **services.msc** and then select **services.msc** from the displayed Programs. The **Services manager** dialog box appears.

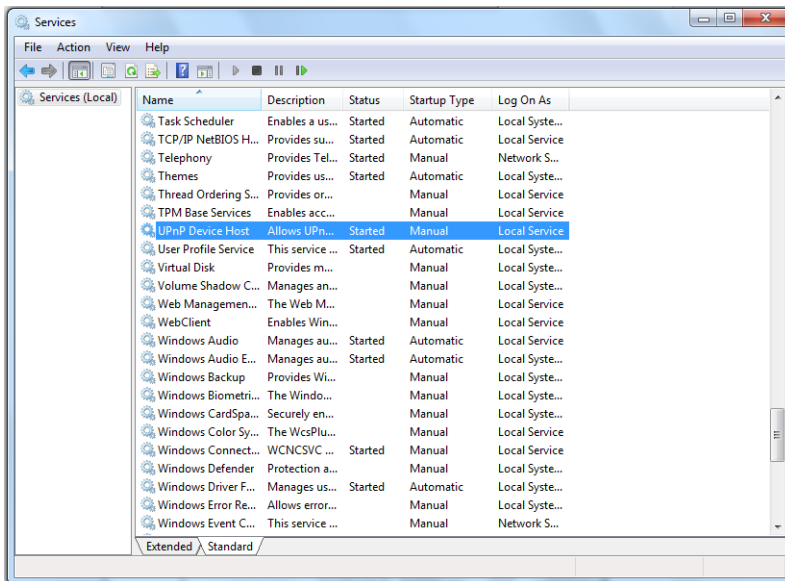

Services Manager Dialog Box

2. In the **Services manager** dialog box, scroll down the list to *UPnP Device Host* and verify that it shows the status *Started*. If *Started* is not displayed, right-click and select **Start** from the shortcut menu.

6.4 Installing and Deleting the Web Player

If you are using Microsoft Internet Explorer to access the camera's browser-based interface, the Quasar Player enables you to view live video from the camera.

After logging into the unit, the following information bar is displayed:

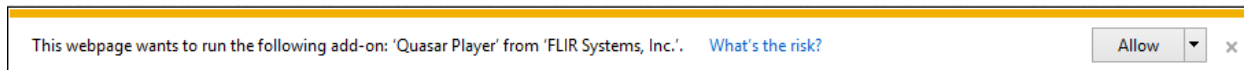

"Run Quasar Player" Information Bar

Click **Allow**.

If the Quasar Player has been loaded previously, the **Live View** window opens.

If this is a first-time installation of the camera, the Quasar Player installation wizard opens after accessing the camera.

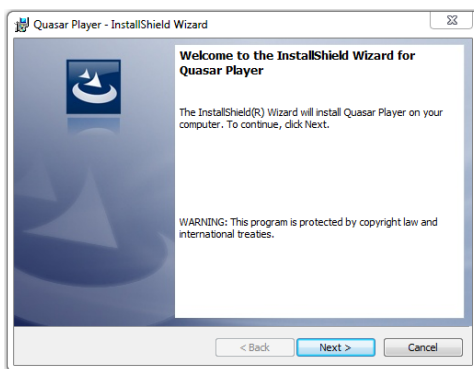

Quasar Player Installation Wizard

To install the Quasar Player

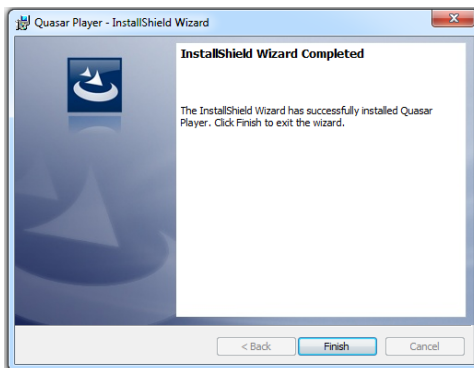

1. Click Next. The Player is installed.
2. Click **Finish** when the next screen opens. The installation is completed. **Quasar Player** is displayed in the list of installed programs.



Quasar Player Installation Completed

Users who have previously installed the DVPlayer or DCViewer web player in the PC should first delete the existing player file from the PC and then install the Quasar Player before accessing the camera.

To delete an existing DVPlayer or DCViewer file

1. Click  or  (**Start**) and open the Control Panel.
2. In the Control Panel, click *Uninstall a program* (Win 7, 8, or 8.1) or *Programs and Features* (Win 10).
3. From the list of installed programs, select **DVPlayer** or **DCViewer**.

4. Do one of the following:
 - a. On the banner bar, click *Uninstall* (Win 7, 8, or 8.1).
 - b. Right-click the program, click *Uninstall/Change* (Win 10).
5. When prompted to confirm the Uninstall, click **Yes**.
6. After deleting the previous player file, you must clear your computer's cache memory.

To clear your computer's cache memory

1. In the Control Panel, click **Internet Options**. The **Internet Properties** dialog box opens.
2. From the *Browsing History* section, click **Delete**. The **Delete Browsing History** dialog box opens.
3. From the **Delete Browsing History** dialog box, check *Preserve Favorites website data*, *Temporary Internet files and website files*, *Cookies and website data*, and *Tracking Protection, ActiveX Filtering and Do Not Track*.
4. Click **Delete**. The **Internet Properties** dialog box opens.
5. Click **OK**. Your computer's cache memory is deleted. After the cache is cleared, the Quasar Player installation wizard opens.
6. Follow instructions above to install the Quasar Player.

6.5 Deleting Temporary Internet Files

To improve Internet Explorer performance, it is recommended to clean up all of the temporary Internet files.

To delete temporary Internet files

1. In Internet Explorer (IE), from the Command Bar toolbar, click **Tools** and select *Internet Options* from the menu that appears.

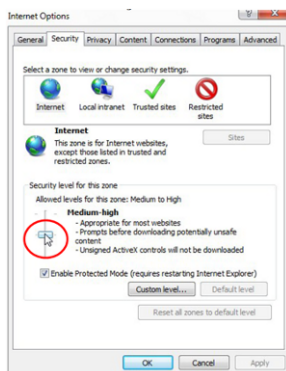

Tools > Internet Options Dialog Box

2. In the **General** tab in the *Internet Options* dialog box, click **Delete**.
3. In the **Delete Browsing History** dialog box that appears, select *Temporary Internet files* (Win 7, 8 or 8.1) or *Temporary Internet files and website files* (Win 10). Uncheck *Cookies* and *History* (Win 7, 8 or 8.1) or *Cookies and website data* (Win 10) to keep this data. Click **Delete**.

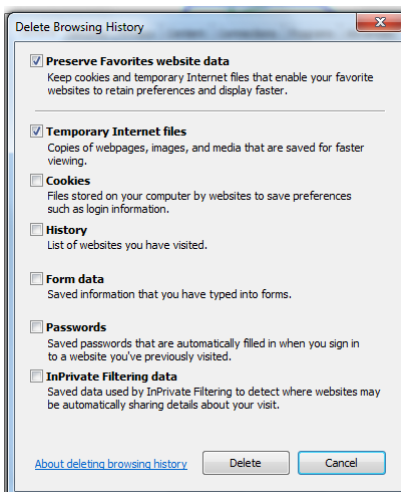

Delete Browsing History Dialog Box



Americas

27700 SW Parkway Ave.
Wilsonville, OR 97070
USA

6769 Hollister Ave
Goleta, CA 93117
USA

Support:

<https://support.flir.com/>

Document:
Quasar Gen III CP-6302 Range User Guide
Version: Ver. 9
Date: December 24, 2021